

VACUUM TUBING AND FITTINGS

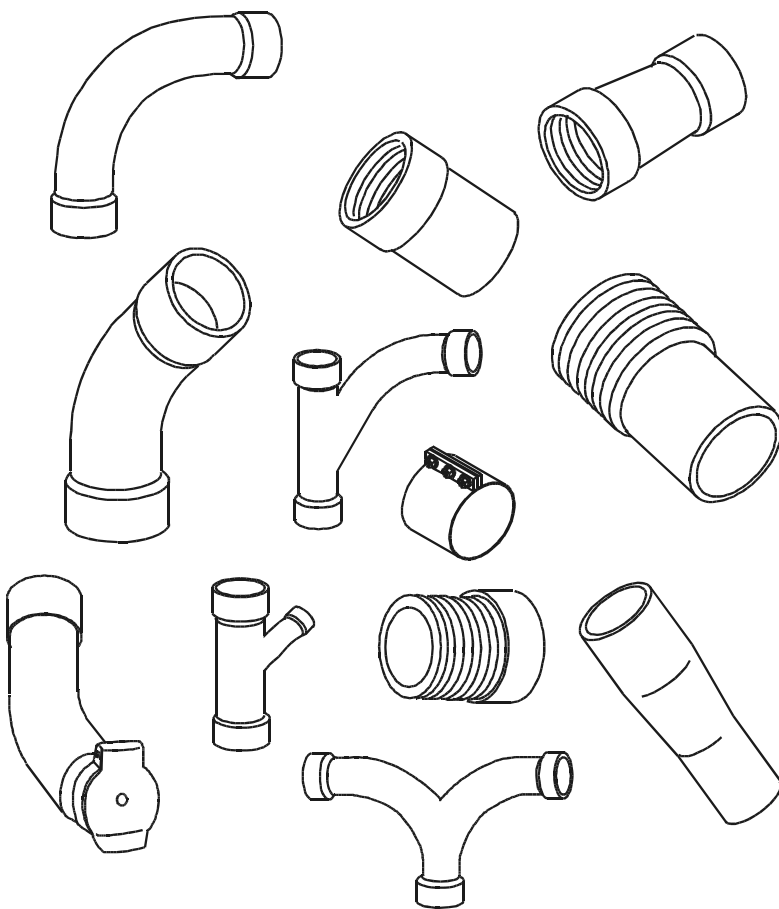

STANDARD TUBING
STANDARD RADIUS ELBOWS
SHORT RADIUS ELBOWS
LONG RADIUS BENDS
STANDARD 90° TY'S
STANDARD 90° TY'S (CONTINUED)
STANDARD 45° YL'S
STANDARD 45° YL'S (CONTINUED)
STANDARD DOUBLE Y'S
STANDARD REDUCING COUPLINGS
COMPRESSION COUPLINGS
SLIP COUPLINGS
SHRINK TAPE
SHRINK SLEEVES
STANDARD MALE ADAPTERS
STANDARD FEMALE ADAPTERS
FEMALE ADAPTERS EXPANDED
90° ADAPTER ELBOW
ADAPTER TEES
MALE ADAPTER NIPPLE
FEMALE REDUCING ADAPTER
FEMALE REDUCING ADAPTER EXPANDED
45° FEMALE ADAPTER ELBOW
THREADED INLET VALVES
INLET VALVES
ESCUTCHEON PLATES
WRENCH
WORK STATIONS – HEAD ONLY
TUBE PLUGS
TUBE HANGERS
INSTALLATION COMPONENTS
INSTALLATION COMPONENTS (CONTINUED)

For Vacuum Cleaning Systems

STANDARD TUBING

(Zinc Coated Galvanized)

AVAILABLE:

- 1 1/2" through 14" O.D.
- Wall thickness: 18, 16, 14, 12 & 11 gauge
- Carbon, Stainless & Aluminum on request

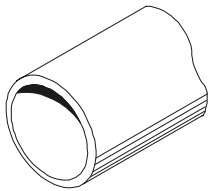

O.D.	Gauge	Nominal Wall Thickness	Standard Lengths	Part No. (MPT)
2"	18	.049"	12'	ATL-18WT200A
2 1/8"	18	.049"	10'	ATL-18WT212A
2 1/8"	16	.065"	10'	ATL-16WT212A
2 1/2"	16	.065"	10'	ATL-16WT250A
3"	16	.065"	10'	ATL-16WT300A
3 1/2"	16	.065"	10'	ATL-16WT350A
4"	16	.065"	10'	ATL-16WT400A
5"	14	.083"	10'	ATL-14WT500A
6"	16	.065"	10'	TUB-16WT600A
6"	14	.083"	10'	TUB-14WT600A
8"	14	.083"	10'	TRO-0AZ08026
10"	12	.105"	10'	TRO-0AZ10028
12"	12	.109"	10'	TRO-0AZ12028
14"	12	.109"	10'	TRO-0OZ14028

Our standard stock lengths can be cut to your specifications upon request

Legend:

O.D. : Outside Diameter
 All reference dimensions
 are nominal.

STANDARD RADIUS ELBOWS

(Zinc Coated Galvanized)

AVAILABLE:

- Carbon, stainless and aluminum elbows
- 11 gauge elbows (straight ends only)
- Expanded one end only
- Up to 14" standard radius elbows
- 30° and 60° elbows
- Expanded ends standard through 6" size
- Straight ends by request (all sizes)

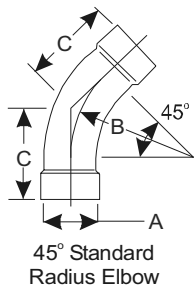
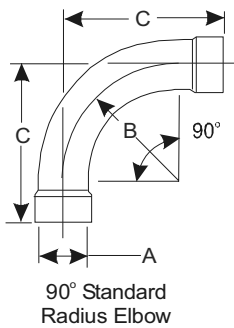

A OD	B CLR	GA.	TAN.	C	90° PART NO. (MTF-EN1)	C	45° PART NO. (MTF-EN1)
2 ¹ / ₈ "	5"	16	2"	7"	ZE021900	4 ⁵ / ₁₆ "	ZE021450
2 ¹ / ₂ "	6"	16	2"	8"	ZE025900	4 ¹ / ₂ "	ZE025450
3"	7 ¹ / ₂ "	16	2"	9 ¹ / ₂ "	ZE030900	5 ¹ / ₈ "	ZE030450
3 ¹ / ₂ "	8 ³ / ₄ "	16	2"	10 ¹ / ₄ "	ZE035900	5 ⁵ / ₈ "	ZE035450
4"	10"	16	2"	12"	ZE040900	6 ¹ / ₈ "	ZE040450
5"	12 ¹ / ₂ "	14	2 ⁵ / ₈ "	15 ¹ / ₈ "	ZE050900	7 ¹³ / ₁₆ "	ZE050450
6"	15"	14	3 ¹ / ₄ "	18 ¹ / ₄ "	ZE060900	9 ¹⁵ / ₃₂ "	ZE060450
8"	20"	14	4 ¹ / ₄ "	24 ¹ / ₄ "	ZS080900	12 ¹⁷ / ₃₂ "	ZS080450
10"	32"	12	15"	47"	ZS100900	28 ¹ / ₄ "	ZS100450
12"	36"	12	6 ¹ / ₄ "	42 ¹ / ₄ "	ZS120900	21 ⁵ / ₃₂ "	ZS120450
14"	36"	12	7 ¹ / ₄ "	43 ¹ / ₄ "	ZS140900	22 ⁵ / ₃₂ "	ZS140450

Expansion depth: 1¹/₄" through 4" OD and 1¹/₂" for 5" and 6" OD.
Stainless parts (10" or larger OD) are segmented.

Legend:

O.D.: Outside Diameter
CLR.: Center Line Radius
GA.: Gauge
TAN.: Tangent Length
All reference dimensions
are nominal.

SHORT RADIUS ELBOWS

(Zinc Coated Galvanized)

AVAILABLE:

- Carbon, stainless and aluminum elbows
- 11 gauge elbows (straight ends only)
- Expanded one end only
- Up to 14" standard radius elbows
- 30° and 60° elbows
- Expanded ends standard through 6" size
- Straight ends by request (all sizes)

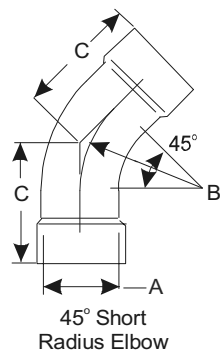
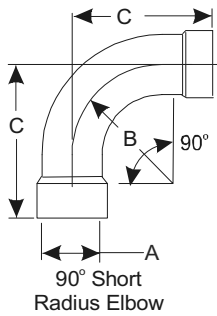

A OD	B (CLR)	GA	TAN.	C	90° PART NO. (MTF-ES1)	C	45° PART NO. (MTF-ES1)
2"	2 ¹ / ₄ "	16	2"	4 ⁷ / ₁₆ "	ZE020900	3 ¹ / ₁₆ "	ZE020450
3"	3 ¹ / ₂ "	16	2"	6 ¹ / ₂ "	ZE030900	3 ⁷ / ₈ "	ZE030450
4"	6"	16	2"	8"	ZE040900	4 ¹ / ₂ "	ZE040450
5"	5 ¹ / ₂ "	14	2 ⁵ / ₈ "	10 ¹ / ₈ "	ZE050900	5 ²³ / ₃₂ "	ZE050450
6"	9"	14	3 ¹ / ₄ "	12 ¹ / ₄ "	ZE060900	6 ³¹ / ₃₂ "	ZE060450
8"	12"	14	4 ¹ / ₄ "	16 ¹ / ₄ "	ZS080900	9 ⁷ / ₃₂ "	ZE080450

Expansion depth: 1¹/₄" through 4" OD and 1¹/₂" for 5" and 6" OD.

Legend:

O.D. : Outside Diameter
 CLR.: Center Line Radius
 GA.: Gauge
 TAN.: Tangent Length
 All reference dimensions
 are nominal.

LONG RADIUS BENDS

(Zinc Coated Galvanized)

AVAILABLE:

- Carbon, stainless and aluminum bends
- Expanded ends available upon request, except on 8" and 10" bends & all 11 gauge bends.

A OD	B (CLR)	GA	C	90° PART NO. (MTF-EL1)	C	45° PART NO. (MTF-EL1)
2 ¹ / ₈ "	24"	16	30"	Z0219024	15 ¹⁵ / ₁₆ "	Z0214524
2 ¹ / ₈ "	36"	16	42"	Z0219036	20 ¹⁵ / ₁₆ "	Z0214536
2 ¹ / ₂ "	24"	16	30"	Z0259024	15 ¹⁵ / ₁₆ "	Z0254524
2 ¹ / ₂ "	36"	16	42"	Z0259036	20 ¹⁵ / ₁₆ "	Z0254536
3"	24"	16	30"	Z0309024	15 ¹⁵ / ₁₆ "	Z0304524
3"	30"	16	30"	Z0309030	18 ⁷ / ₁₆ "	Z0304530
3"	36"	16	42"	Z0309036	20 ¹⁵ / ₁₆ "	Z0304536
3"	38"	16	44"	Z0309038	21 ³ / ₄ "	Z0304538
3"	48"	16	54"	Z0309048	25 ⁷ / ₈ "	Z0304548
3 ¹ / ₂ "	30"	16	37"	Z0359030	19 ⁷ / ₁₆ "	Z0354530
3 ¹ / ₂ "	36"	16	43"	Z0359036	21 ¹⁵ / ₁₆ "	Z0354536
3 ¹ / ₂ "	48"	16	55"	Z0359048	26 ⁷ / ₈ "	Z0354548
4"	24"	16	32"	Z0409024	17 ¹⁵ / ₁₆ "	Z0404524
4"	30"	16	28"	Z0409030	20 ⁷ / ₁₆ "	Z0404530
4"	36"	16	44"	Z0409036	22 ¹⁵ / ₁₆ "	Z0404536
4"	48"	16	56"	Z0409048	27 ⁷ / ₈ "	Z0404548
4"	60"	16	68"	Z0409060	32 ⁷ / ₈ "	Z0404560
5"	30"	14	40"	Z0509030	22 ⁷ / ₁₆ "	Z0504530
5"	48"	14	58"	Z0509048	29 ⁷ / ₈ "	Z0504548
6"	30"	14	42"	Z0609030	24 ⁷ / ₁₆ "	Z0604530
6"	48"	14	60"	Z0609048	31 ⁷ / ₈ "	Z0604548
6"	60"	14	72"	Z0609060	36 ⁷ / ₈ "	Z0604560
8"	32"	14	48"	Z0809032	25 ¹ / ₄ "	Z0804532
8"	48"	14	64"	Z0809048	31 ⁷ / ₈ "	Z0804548
10"	48"	12	70"	Z1009048	41 ⁷ / ₈ "	Z1004548

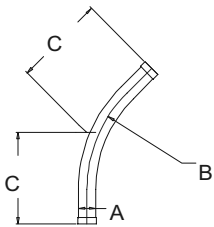
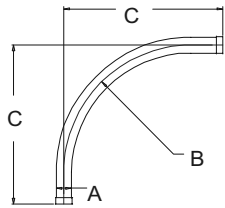

Nominal standard tangent is two times tube OD, 6" Minimum

All standard bends have straight ends

Nominal standard tangent for 10" is 22"

Stainless parts are segmented

Legend:

O.D. : Outside Diameter
 CLR.: Center Line Radius
 GA.: Gauge
 All reference dimensions
 are nominal.

LONG RADIUS BENDS – 11 GAUGE

(Zinc Coated Galvanized)

AVAILABLE:

- Carbon, stainless and aluminum bends
- Expanded ends available upon request, except on 8" and 10" bends & all 11 gauge bends.

A OD	B (CLR)	GA	C	90° PART NO. (MTF-EL2)	C	45° PART NO. (MTF-EL2)
------	---------	----	---	---------------------------	---	---------------------------

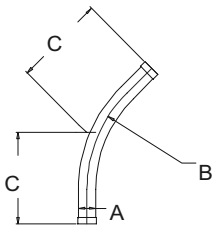
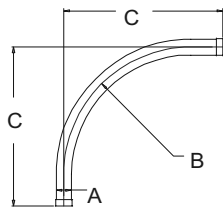

2 1/8"	24"	11	30"	Z0219024	15 15/16"	Z0214524
2 1/8"	36"	11	42"	Z0219036	20 15/16"	Z0214536
2 1/2"	24"	11	30"	Z0259024	15 15/16"	Z0254524
2 1/2"	36"	11	42"	Z0259036	20 15/16"	Z0254536
3"	24"	11	30"	Z0309024	15 15/16"	Z0304524
3"	30"	11	36"	Z0309030	18 7/16"	Z0304530
3"	36"	11	42"	Z0309036	20 15/16"	Z0304536
3"	38"	11	44"	Z0309038	21 3/4"	Z0304538
3"	48"	11	54"	Z0309048	25 7/8"	Z0304548
3 1/2"	30"	11	37"	Z0309030	19 7/16"	Z0304530
3 1/2"	36"	11	43"	Z0359036	21 15/16"	Z0354536
3 1/2"	48"	11	55"	Z0359048	26 7/8"	Z0354548
4"	24"	11	32"	Z0409024	17 15/16"	Z0404524
4"	30"	11	38"	Z0409030	20 7/16"	Z0404530
4"	36"	11	44"	Z0409036	22 15/16"	Z0404536
4"	48"	11	56"	Z0409048	27 7/8"	Z0404548
4"	60"	11	68"	Z0409060	32 7/8"	Z0404560
5"	30"	11	40"	Z0509030	22 7/16"	Z0504530
5"	48"	11	58"	Z0509048	29 7/8"	Z0504548
6"	30"	11	42"	Z0609030	24 7/16"	Z0604530
6"	48"	11	60"	Z0609048	31 7/8"	Z0604548
6"	60"	11	72"	Z0609060	36 7/8"	Z0604560
8"	32"	11	48"	Z0809032	25 1/4"	Z0804532
8"	48"	11	64"	Z0809048	31 7/8"	Z0804548

Nominal standard tangent is two times tube OD, 6" Minimum

All standard bends have straight ends

Nominal standard tangent for 10" is 22"

Stainless parts are segmented

Legend:

O.D. : Outside Diameter
 CLR.: Center Line Radius
 GA.: Gauge
 All reference dimensions
 are nominal.

STANDARD 90° TY'S

(Zinc Coated Galvanized)

AVAILABLE:

- Carbon, stainless & aluminum TY's
- Straight & expanded combinations available
- Straight ends available (all sizes)
- 2" through 14" available
- Wall thickness: 16 gauge: 2" x 2" through to 4" x 4"
14 gauge: 5" x 2" through to 8" x 8"
12 gauge: 10"
(11 gauge available in straight ends only)



SIZE	A OD	B CLR	C	D OD	E	K	PART NO. (MTF-TYB)
2" x 2"	2"	3 1/2"	4 3/4"	2"	5 9/16"	6 3/16"	ZE020020
2 1/8" x 2"	2 1/8"	5"	9 5/32"	2"	8 13/16"	9 1/2"	ZE021020
2 1/8" x 2 1/8"	2 1/8"	5"	9 5/32"	2 1/8"	8 13/16"	9 1/2"	ZE021021
2 1/2" x 2"	2 1/2"	5"	9 11/32"	2"	9"	10"	ZE025020
2 1/2" x 2 1/8"	2 1/2"	5"	9 11/32"	2 1/8"	9"	10"	ZE025021
2 1/2" x 2 1/2"	2 1/2"	6"	10 1/2"	2 1/2"	10 1/32"	10"	ZE025025
3" x 2"	3"	5"	9 19/32"	2"	9 1/4"	10 1/2"	ZE030020
3" x 2 1/8"	3"	5"	9 19/32"	2 1/8"	9 1/4"	10 1/2"	ZE030021
3" x 2 1/2"	3"	6"	10 3/4"	2 1/2"	10 9/32"	10 1/2"	ZE030025
3" x 3"	3"	7 1/2"	12 3/8"	3"	11 25/32"	11 1/2"	ZE030030
3 1/2" x 2"	3 1/2"	5"	9 27/32"	2"	9 1/2"	11"	ZE035020
3 1/2" x 2 1/8"	3 1/2"	5"	9 27/32"	2 1/8"	9 1/2"	11"	ZE035021
3 1/2" x 2 1/2"	3 1/2"	6"	11"	2 1/2"	10 17/32"	11"	ZE035025
3 1/2" x 3"	3 1/2"	7 1/2"	12 5/8"	3"	12 1/32"	13"	ZE035030
3 1/2" x 3 1/2"	3 1/2"	8 3/4"	14 1/8"	3 1/2"	13 11/32"	13"	ZE035035
4" x 2"	4"	5"	10 3/32"	2"	9 3/4"	12"	ZE040020
4" x 2 1/8"	4"	5"	10 3/32"	2 1/8"	9 3/4"	12"	ZE040021
4" x 2 1/2"	4"	6"	11 1/4"	2 1/2"	10 25/32"	12"	ZE040025
4" x 3"	4"	7 1/2"	12 7/8"	3"	12 9/32"	12"	ZE040030
4" x 3 1/2"	4"	8 3/4"	14 3/8"	3 1/2"	13 19/32"	14"	ZE040035
4" x 4"	4"	10"	15 7/8"	4"	14 29/32"	14"	ZE040040
5" x 2"	5"	5"	10 19/32"	2"	10 1/4"	13"	ZE050020
5" x 2 1/8"	5"	5"	10 19/32"	2 1/8"	10 1/4"	13"	ZE050021
5" x 2 1/2"	5"	6"	11 3/4"	2 1/2"	11 9/32"	13"	ZE050025
5" x 3"	5"	7 1/2"	13 3/8"	3"	12 25/32"	15 1/2"	ZE050030
5" x 3 1/2"	5"	8 3/4"	14 7/8"	3 1/2"	14 3/32"	15 1/2"	ZE050035
5" x 4"	5"	10"	16 3/8"	4"	15 13/32"	15 1/2"	ZE050040
5" x 5"	5"	12 1/2"	19 3/8"	5"	18 5/8"	18 1/2"	ZE050050
6" x 2"	6"	5"	11 3/32"	2"	10 3/4"	15"	ZE060020
6" x 2 1/8"	6"	5"	11 3/32"	2 1/8"	10 3/4"	15"	ZE060021
6" x 2 1/2"	6"	6"	12 1/4"	2 1/2"	11 25/32"	15"	ZE060025
6" x 3"	6"	7 1/2"	13 7/8"	3"	13 9/32"	15"	ZE060030
6" x 3 1/2"	6"	8 3/4"	15 3/8"	3 1/2"	14 19/32"	17"	ZE060035
6" x 4"	6"	10"	16 7/8"	4"	15 29/32"	17"	ZE060040
6" x 5"	6"	12 1/2"	19 7/8"	5"	19 1/8"	21"	ZE060050
6" x 6"	6"	15"	22 7/8"	6"	22 11/32"	21"	ZE060060

Legend:

O.D. : Outside Diameter
CLR.: Center Line Radius
All reference dimensions
are nominal.

STANDARD 90° TY'S (CONTINUED)

(Zinc Coated Galvanized)

AVAILABLE:

- Carbon, stainless & aluminum TY's
- Straight & expanded combinations available
- Straight ends available (all sizes)
- 2" through 14" available
- Wall thickness: 16 gauge: 2" x 2" through to 4" x 4"
14 gauge: 5" x 2" through to 8" x 8"
12 gauge: 10" x 2" through 14" x 14"
(11 gauge available in straight ends only)

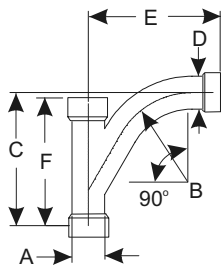

SIZE	A OD	B CLR	C	D OD	E	F	PART NO. (MTF-TYB)
8" x 2"	8"	5"	12 ³ / ₃₂ "	2"	11 ³ / ₄ "	18"	ZE080020
8" x 2 ¹ / ₈ "	8"	5"	12 ³ / ₃₂ "	2 ¹ / ₈ "	11 ³ / ₄ "	18"	ZE080021
8" x 2 ¹ / ₂ "	8"	6"	13 ¹ / ₄ "	2 ¹ / ₂ "	12 ²⁵ / ₃₂ "	18"	ZE080025
8" x 3"	8"	7 ¹ / ₂ "	14 ⁷ / ₈ "	3"	14 ⁹ / ₃₂ "	18"	ZE080030
8" x 3 ¹ / ₂ "	8"	8 ³ / ₄ "	16 ³ / ₈ "	3 ¹ / ₂ "	15 ¹⁹ / ₃₂ "	21"	ZE080035
8" x 4"	8"	10"	17 ⁷ / ₈ "	4"	16 ²⁹ / ₃₂ "	21"	ZE080040
8" x 5"	8"	12 ¹ / ₂ "	20 ⁷ / ₈ "	5"	20 ¹ / ₈ "	24"	ZE080050
8" x 6"	8"	15"	23 ⁷ / ₈ "	6"	23 ¹¹ / ₃₂ "	24"	ZE080060
8" x 8"	8"	20"	29 ⁷ / ₈ "	8"	29 ¹⁷ / ₃₂ "	29"	ZE080080
10" x 2"	10"	5"	13 ³ / ₃₂ "	2"	12 ³ / ₄ "	21"	ZE100020
10" x 2 ¹ / ₈ "	10"	5"	13 ³ / ₃₂ "	2 ¹ / ₈ "	12 ³ / ₄ "	21"	ZE100021
10" x 2 ¹ / ₂ "	10"	6"	14 ¹ / ₄ "	2 ¹ / ₂ "	13 ²⁵ / ₃₂ "	21"	ZE100025
10" x 3"	10"	7 ¹ / ₂ "	15 ⁷ / ₈ "	3"	15 ⁹ / ₃₂ "	21"	ZE100030
10" x 3 ¹ / ₂ "	10"	8 ³ / ₄ "	17 ³ / ₈ "	3 ¹ / ₂ "	16 ¹⁷ / ₃₂ "	24"	ZE100035
10" x 4"	10"	10"	18 ⁷ / ₈ "	4"	17 ²⁹ / ₃₂ "	24"	ZE100040
10" x 5"	10"	12 ¹ / ₂ "	21 ⁷ / ₈ "	5"	21 ¹ / ₈ "	24"	ZE100050
10" x 6"	10"	15"	24 ⁷ / ₈ "	6"	24 ¹¹ / ₃₂ "	28"	ZE100060
10" x 8"	10"	20"	30 ⁷ / ₈ "	8"	30 ¹⁷ / ₃₂ "	32"	ZE100080
10" x 10"	10"	32"	40 ³ / ₈ "	10"	42 ²⁵ / ₃₂ "	36"	ZE100100
12" x 2 ¹ / ₈ "	12"	5"	14 ³ / ₃₂ "	2 ¹ / ₈ "	13 ³ / ₄ "	24"	ZE120021
12" x 2 ¹ / ₂ "	12"	6"	15 ¹ / ₄ "	2 ¹ / ₂ "	14 ²⁵ / ₃₂ "	24"	ZE120025
12" x 3"	12"	7 ¹ / ₂ "	16 ⁷ / ₈ "	3"	16 ⁹ / ₃₂ "	24"	ZE120030
12" x 3 ¹ / ₂ "	12"	8 ³ / ₄ "	18 ³ / ₈ "	3 ¹ / ₂ "	17 ¹⁹ / ₃₂ "	27"	ZE120035
12" x 4"	12"	10"	19 ⁷ / ₈ "	4"	18 ²⁹ / ₃₂ "	27"	ZE120040
12" x 5"	12"	12 ¹ / ₂ "	22 ⁷ / ₈ "	5"	22 ¹ / ₈ "	27"	ZE120050
12" x 6"	12"	15"	25 ⁷ / ₈ "	6"	25 ¹¹ / ₃₂ "	31"	ZE120060
12" x 8"	12"	20"	31 ⁷ / ₈ "	8"	31 ¹⁷ / ₃₂ "	35"	ZE120080
12" x 10"	12"	32"	41 ³ / ₈ "	10"	43 ²⁵ / ₃₂ "	39"	ZE120100
12" x 12"	12"	36"+	46 ⁷ / ₈ "	12"	49 ¹ / ₈ "	43"	ZE120120
14" x 8"	14"	20"	32 ⁷ / ₈ "	8"	32 ¹⁷ / ₂₃ "	38"	ZE140080
14" x 10"	14"	32"	42 ³ / ₈ "	10"	44 ²⁵ / ₃₂ "	42"	ZE140100
14" x 12"	14"	36"+	47 ⁷ / ₈ "	12"	50 ¹ / ₈ "	46"	ZE140120
14" x 14"	14"	36"+	51 ³ / ₈ "	14"	50 ³ / ₄ "	52"	ZE140140

Legend:

O.D. : Outside Diameter
CLR.: Center Line Radius
All reference dimensions
are nominal.

- * Expanded ends standard through 6" size
- + Segmented

STANDARD 45° YL'S

(Zinc Coated Galvanized)

AVAILABLE:

- Carbon, stainless & aluminum YL's
- Straight & expanded combinations available
- Straight ends available (all sizes)
- 2" through 14" available
- Wall thickness: 16 gauge: 2" x 2" through to 4" x 4"
14 gauge: 5" x 2" through to 8" x 8"
12 gauge: 10"
(11 gauge available in straight ends only)

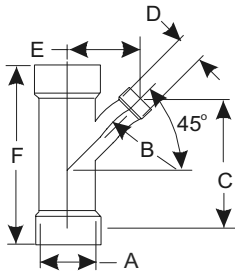

SIZE	A OD	B CLR	C	D OD	E	F	PART NO. (MTF-YLB)
2" x 2"	2"	5"	4 ^{11/16} "	2"	2 ^{21/32} "	6 ^{3/16} "	ZE020020
2 ^{1/8} " x 2"	2 ^{1/8} "	5"	9 ^{3/32} "	2 ^{1/8} "	4 ^{11/16} "	9 ^{1/2} "	ZE021020
2 ^{1/8} " x 2 ^{1/8} "	2 ^{1/8} "	5"	9 ^{3/32} "	2 ^{1/8} "	4 ^{11/16} "	9 ^{1/2} "	ZE021021
2 ^{1/2} " x 2"	2 ^{1/2} "	5"	9 ^{9/32} "	2"	4 ^{7/8} "	10"	ZE025020
2 ^{1/2} " x 2 ^{1/8} "	2 ^{1/2} "	5"	9 ^{9/32} "	2 ^{1/8} "	4 ^{7/8} "	10"	ZE025021
2 ^{1/2} " x 2 ^{1/2} "	2 ^{1/2} "	6"	10 ^{5/32} "	2 ^{1/2} "	5 ^{3/16} "	10"	ZE025025
3" x 2"	3"	5"	9 ^{17/32} "	2"	5 ^{1/8} "	10 ^{1/2} "	ZE030020
3" x 2 ^{1/8} "	3"	5"	9 ^{17/32} "	2 ^{1/8} "	5 ^{1/8} "	10 ^{1/2} "	ZE030021
3" x 2 ^{1/2} "	3"	6"	10 ^{13/32} "	2 ^{1/2} "	5 ^{7/16} "	10 ^{1/2} "	ZE030025
3" x 3"	3"	7 ^{1/2} "	11 ^{19/32} "	3"	5 ^{29/32} "	11 ^{1/2} "	ZE030030
3 ^{1/2} " x 2"	3 ^{1/2} "	5"	9 ^{5/32} "	2"	5 ^{3/8} "	11"	ZE035020
3 ^{1/2} " x 2 ^{1/8} "	3 ^{1/2} "	5"	9 ^{25/32} "	2 ^{1/8} "	5 ^{3/8} "	11"	ZE035021
3 ^{1/2} " x 2 ^{1/2} "	3 ^{1/2} "	6"	10 ^{21/32} "	2 ^{1/2} "	5 ^{11/16} "	11"	ZE035025
3 ^{1/2} " x 3"	3 ^{1/2} "	7 ^{1/2} "	11 ^{27/32} "	3"	6 ^{5/32} "	13"	ZE035030
3 ^{1/2} " x 3 ^{1/2} "	3 ^{1/2} "	8 ^{3/4} "	12 ^{31/32} "	3 ^{1/2} "	6 ^{9/16} "	13"	ZE035035
4" x 2"	4"	5"	10 ^{1/32} "	2"	5 ^{5/8} "	12"	ZE040020
4" x 2 ^{1/8} "	4"	5"	10 ^{1/32} "	2 ^{1/8} "	5 ^{5/8} "	12"	ZE040021
4" x 2 ^{1/2} "	4"	6"	10 ^{29/32} "	2 ^{1/2} "	5 ^{15/16} "	12"	ZE040025
4" x 3"	4"	7 ^{1/2} "	12 ^{3/32} "	3"	6 ^{13/32} "	12"	ZE040030
4" x 3 ^{1/2} "	4"	8 ^{3/4} "	13 ^{7/32} "	3 ^{1/2} "	6 ^{13/16} "	14"	ZE040035
4" x 4"	4"	10"	14 ^{11/32} "	4"	7 ^{1/4} "	14"	ZE040040
5" x 2"	5"	5"	10 ^{17/32} "	2"	6 ^{1/8} "	13"	ZE050020
5" x 2 ^{1/8} "	5"	5"	10 ^{17/32} "	2 ^{1/8} "	6 ^{1/8} "	13"	ZE050021
5" x 2 ^{1/2} "	5"	6"	11 ^{13/32} "	2 ^{1/2} "	6 ^{7/16} "	13"	ZE050025
5" x 3"	5"	7 ^{1/2} "	12 ^{19/32} "	3"	6 ^{29/32} "	15 ^{1/2} "	ZE050030
5" x 3 ^{1/2} "	5"	8 ^{3/4} "	13 ^{23/32} "	3 ^{1/2} "	7 ^{5/16} "	15 ^{1/2} "	ZE050035
5" x 4"	5"	10"	14 ^{27/32} "	4"	7 ^{3/4} "	15 ^{1/2} "	ZE050040
5" x 5"	5"	12 ^{1/2} "	17 ^{9/16} "	5"	9"	18 ^{1/2} "	ZE050050
6" x 2"	6"	5"	11 ^{1/32} "	2"	6 ^{5/8} "	15"	ZE060020
6" x 2 ^{1/8} "	6"	5"	11 ^{1/32} "	2 ^{1/8} "	6 ^{5/8} "	15"	ZE060021
6" x 2 ^{1/2} "	6"	6"	11 ^{29/32} "	2 ^{1/2} "	6 ^{15/16} "	15"	ZE060025
6" x 3"	6"	7 ^{1/2} "	13 ^{3/32} "	3"	7 ^{13/32} "	15"	ZE060030
6" x 3 ^{1/2} "	6"	8 ^{3/4} "	14 ^{7/32} "	3 ^{1/2} "	7 ^{13/16} "	17"	ZE060035
6" x 4"	6"	10"	15 ^{11/32} "	4"	8 ^{1/4} "	17"	ZE060040
6" x 5"	6"	12 ^{1/2} "	18 ^{1/16} "	5"	9 ^{1/2} "	21"	ZE060050

Legend:

O.D. : Outside Diameter
CLR.: Center Line Radius
All reference dimensions
are nominal.

STANDARD 45° YL'S (CONTINUED)

(Zinc Coated Galvanized)

AVAILABLE:

- Carbon, stainless & aluminum YL's
- Straight & expanded combinations available
- Straight ends available (all sizes)
- 2" through 14" available
- Wall thickness: 16 gauge: 2" x 2" through to 4" x 4"
14 gauge: 5" x 2" through to 8" x 8"
12 gauge: 10" x 2" through to 14" x 14"
(11 gauge available in straight ends only)

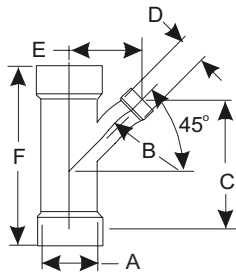

SIZE	A OD	B CLR	C	D OD	E	F	PART NO. (MTF-YLB)
6" x 6"	6"	15"	20 ^{25/32} "	6"	10 ^{25/32} "	21"	ZE060060
8" x 2"	8"	5"	12 ^{1/32} "	2"	7 ^{5/8} "	18"	ZE080020
8" x 2 ^{1/8} "	8"	5"	12 ^{1/32} "	2 ^{1/8} "	7 ^{5/8} "	18"	ZE080021
8" x 2 ^{1/2} "	8"	6"	12 ^{29/32} "	2 ^{1/2} "	7 ^{15/16} "	18"	ZE080025
8" x 3"	8"	7 ^{1/2} "	14 ^{3/32} "	3"	8 ^{13/32} "	18"	ZE080030
8" x 3 ^{1/2} "	8"	8 ^{3/4} "	15 ^{7/32} "	3 ^{1/2} "	8 ^{13/16} "	21"	ZE080035
8" x 4"	8"	10"	16 ^{11/32} "	4"	9 ^{1/4} "	21"	ZE080040
8" x 5"	8"	12 ^{1/2} "	19 ^{1/16} "	5"	10 ^{1/2} "	24"	ZE080050
8" x 6"	8"	15"	21 ^{25/32} "	6"	11 ^{25/32} "	24"	ZE080060
8" x 8"	8"	20"	27"	8"	14 ^{5/32} "	29"	ZE080080
10" x 2"	10"	5"	13 ^{1/32} "	2"	8 ^{5/8} "	21"	ZE100020
10" x 2 ^{1/8} "	10"	5"	13 ^{1/32} "	2 ^{1/8} "	8 ^{5/8} "	21"	ZE100021
10" x 2 ^{1/2} "	10"	6"	13 ^{29/32} "	2 ^{1/2} "	8 ^{15/16} "	21"	ZE100025
10" x 3"	10"	7 ^{1/2} "	15 ^{3/32} "	3"	9 ^{13/32} "	21"	ZE100030
10" x 3 ^{1/2} "	10"	8 ^{3/4} "	16 ^{7/32} "	3 ^{1/2} "	9 ^{13/16} "	24"	ZE100035
10" x 4"	10"	10"	17 ^{11/32} "	4"	10 ^{1/4} "	24"	ZE100040
10" x 5"	10"	12 ^{1/2} "	20 ^{1/16} "	5"	11 ^{1/2} "	24"	ZE100050
10" x 6"	10"	15"	22 ^{3/4} "	6"	12 ^{25/32} "	28"	ZE100060
10" x 8"	10"	20"	28"	8"	15 ^{5/32} "	32"	ZE100080
10" x 10"	10"	32"	34 ^{11/16} "	10"	18 ^{5/8} "	36"	ZE100100
12" x 2 ^{1/8} "	12"	5"	14 ^{1/32} "	2 ^{1/8} "	9 ^{5/8} "	24"	ZE120021
12" x 2 ^{1/2} "	12"	6"	14 ^{29/32} "	2 ^{1/2} "	9 ^{31/32} "	24"	ZE120025
12" x 3"	12"	7 ^{1/2} "	16 ^{3/32} "	3"	10 ^{13/32} "	24"	ZE120030
12" x 3 ^{1/2} "	12"	8 ^{3/4} "	17 ^{7/32} "	3 ^{1/2} "	10 ^{13/16} "	27"	ZE120035
12" x 4"	12"	10"	18 ^{11/32} "	4"	11 ^{1/4} "	27"	ZE120040
12" x 5"	12"	12 ^{1/2} "	21 ^{1/16} "	5"	12 ^{1/2} "	27"	ZE120050
12" x 6"	12"	15"	23 ^{3/4} "	6"	13 ^{25/32} "	31"	ZE120060
12" x 8"	12"	20"	29"	8"	16 ^{5/32} "	35"	ZE120080
12" x 10"	12"	32"	35 ^{11/16} "	10"	19 ^{5/8} "	39"	ZE120100
12" x 12"	12"	36"	40 ^{3/4} "	12"	21 ^{27/32} "	43"	ZE120120
14" x 8"	14"	20"	30"	8"	17 ^{5/32} "	38"	ZE120080
14" x 10"	14"	32"	36 ^{11/32} "	10"	20 ^{5/8} "	42"	ZE140100
14" x 12"	14"	36"+	41 ^{3/4} "	12"	22 ^{27/32} "	46"	ZE140120
14" x 14"	14"	36"+	45 ^{15/16} "	14"	24 ^{13/32} "	52"	ZE140140

Legend:

O.D. : Outside Diameter
CLR.: Center Line Radius
All reference dimensions
are nominal.

- * Expanded ends standard through 6"
- + Segmented

STANDARD DOUBLE Y'S

(Zinc Coated Galvanized)

AVAILABLE:

- Carbon, stainless & aluminum double Y's
- 2" through 14" available
- Straight & expanded combinations available
- Wall thickness: 16 , 14 gauge
- Straight ends available (all sizes)
- (11 gauge available in straight ends only)

STANDARD DOUBLE 90° YL's

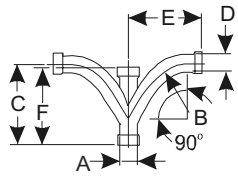

Standard Double 90° TY

SIZE	GA	A OD	B CLR	C	D OD	E	F	PART NO. (MTF-DTY)
2"	16	2"	5"	9 ⁵ / ₃₂ "	2"	8 ¹³ / ₁₆ "	9 ¹ / ₂ "	ZE020020
2 ¹ / ₈ "	16	2 ¹ / ₈ "	5"	9 ⁵ / ₃₂ "	2 ¹ / ₈ "	8 ¹³ / ₁₆ "	9 ¹ / ₂ "	ZE021021
2 ¹ / ₂ "	16	2 ¹ / ₂ "	6"	10 ¹ / ₂ "	2 ¹ / ₂ "	10 ¹ / ₃₂ "	10"	ZE025025
3"	16	3"	7 ¹ / ₂ "	12 ³ / ₈ "	3"	11 ²⁵ / ₃₂ "	11 ¹ / ₂ "	ZE030030
3 ¹ / ₂ "	16	3 ¹ / ₂ "	8 ³ / ₄ "	14 ¹ / ₈ "	3 ¹ / ₂ "	13 ¹¹ / ₃₂ "	13"	ZE035035
4"	16	4"	10"	15 ⁷ / ₈ "	4"	14 ²⁹ / ₃₂ "	14"	ZE040040
5"	14	5"	12 ¹ / ₂ "	19 ³ / ₈ "	5"	18 ⁵ / ₈ "	18 ¹ / ₂ "	ZE050050
6"	14	6"	15"	22 ⁷ / ₈ "	6"	22 ¹¹ / ₃₂ "	21"	ZE060060

STANDARD DOUBLE 45° YL's

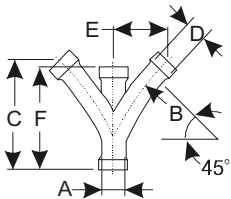

Standard Double 45° YL

SIZE	GA	A OD	B CLR	C	D OD	E	F	PART NO. (MTF-DYL)
2"	16	2"	5"	9 ³ / ₃₂ "	2"	4 ¹¹ / ₁₆ "	9 ¹ / ₂ "	ZE202020
2 ¹ / ₈ "	16	2 ¹ / ₈ "	5"	9 ³ / ₃₂ "	2 ¹ / ₈ "	4 ¹¹ / ₁₆ "	9 ¹ / ₂ "	ZE212121
2 ¹ / ₂ "	16	2 ¹ / ₂ "	6"	10 ⁵ / ₃₂ "	2 ¹ / ₂ "	5 ³ / ₁₆ "	10"	ZE252525
3"	16	3"	7 ¹ / ₂ "	11 ¹⁹ / ₃₂ "	3"	5 ²⁹ / ₃₂ "	11 ¹ / ₂ "	ZE303030
3 ¹ / ₂ "	16	3 ¹ / ₂ "	8 ³ / ₄ "	12 ³¹ / ₃₂ "	3-1/2"	6 ⁹ / ₁₆ "	13"	ZE353535
4"	16	4"	10"	14 ¹¹ / ₃₂ "	4"	7 ¹ / ₄ "	14"	ZE404040
5"	14	5"	12 ¹ / ₂ "	17 ⁹ / ₁₆ "	5"	9"	18 ¹ / ₂ "	ZE505050
6"	14	6"	15"	20 ²⁵ / ₃₂ "	6"	10 ¹⁵ / ₃₂ "	21"	ZE606060

STANDARD DOUBLE 90° Y's

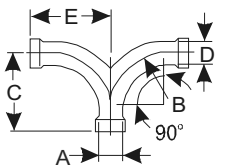

Standard Double 90° Y

SIZE	GA	A OD	B CLR	C	D OD	E	F	PART NO. (MTF-D9Y)
2"	16	2"	5"	7"	2"	7"	9 ¹ / ₂ "	ZE020020
2 ¹ / ₈ "	16	2 ¹ / ₈ "	5"	7"	2 ¹ / ₈ "	7"	9 ¹ / ₂ "	ZE021021
2 ¹ / ₂ "	16	2 ¹ / ₂ "	6"	8"	2 ¹ / ₂ "	8"	10"	ZE252525
3"	16	3"	7 ¹ / ₂ "	9 ¹ / ₂ "	3"	9 ¹ / ₂ "	11 ¹ / ₂ "	ZE303030
3 ¹ / ₂ "	16	3 ¹ / ₂ "	8 ³ / ₄ "	10 ³ / ₄ "	3 ¹ / ₂ "	10 ³ / ₄ "	13"	ZE353535
4"	16	4"	10"	12"	4"	12"	14"	ZE404040
5"	14	5"	12 ¹ / ₂ "	15 ¹ / ₈ "	5"	15 ¹ / ₈ "	18 ¹ / ₂ "	ZE505050
6"	14	6"	15"	18 ¹ / ₄ "	6"	18 ¹ / ₄ "	21"	ZE606060

Legend:

O.D. : Outside Diameter
 CLR.: Center Line Radius
 All reference dimensions
 are nominal.

STANDARD REDUCING COUPLINGS

(Zinc Coated Galvanized)

AVAILABLE:

- Carbon, stainless & aluminum reducer couplings
- 2" through 14" available
- Straight ends available (all sizes)
- Wall thickness: 16, 14 or 12 gauge (11 gauge available in straight ends only)

SIZE	GA	A OD	B	C	D ID/OD	GA	E	PART NO. (MTF-RC1)
2 ¹ / ₈ " x 2"	16	2 ¹ / ₈ "	4"	1 ¹ / ₈ "	2" I.D.	16	2"	ZE021020
2 ¹ / ₂ " x 2"	16	2 ¹ / ₂ "	4 ¹ / ₂ "	1 ¹ / ₄ "	2" I.D.	16	1 ¹ / ₂ "	ZE025020
2 ¹ / ₂ " x 2 ¹ / ₈ "	16	2 ¹ / ₂ "	4 ¹ / ₂ "	1 ¹ / ₄ "	2 ¹ / ₈ " I.D.	16	1 ¹ / ₂ "	ZE025021
3" x 2"	16	3"	8 ³ / ₄ "	1 ¹ / ₄ "	2" I.D.	16	2"	ZE030020
3" x 2 ¹ / ₈ "	16	3"	8 ³ / ₄ "	1 ¹ / ₄ "	2 ¹ / ₈ " I.D.	16	2"	ZE030021
3" x 2 ¹ / ₂ "	16	3"	5"	1 ¹ / ₄ "	2 ¹ / ₂ " I.D.	16	1 ¹ / ₂ "	ZE030025
3 ¹ / ₂ " x 2"	16	3 ¹ / ₂ "	11"	1 ¹ / ₄ "	2" I.D.	16	2"	ZE035020
3 ¹ / ₂ " x 2 ¹ / ₈ "	16	3 ¹ / ₂ "	11"	1 ¹ / ₄ "	2 ¹ / ₈ " I.D.	16	2"	ZE035021
3 ¹ / ₂ " x 2 ¹ / ₂ "	16	3 ¹ / ₂ "	9 ¹ / ₄ "	1 ¹ / ₄ "	2 ¹ / ₂ " I.D.	16	2 ⁷ / ₈ "	ZE035025
3 ¹ / ₂ " x 3"	16	3 ¹ / ₂ "	5 ¹ / ₂ "	1 ¹ / ₄ "	3" I.D.	16	1 ¹ / ₂ "	ZE035030
4" x 2"	16	4"	13 ¹ / ₂ "	1 ¹ / ₄ "	2" I.D.	16	2"	ZE040020
4" x 2 ¹ / ₈ "	16	4"	13 ¹ / ₂ "	1 ¹ / ₄ "	2 ¹ / ₈ " I.D.	16	2"	ZE040021
4" x 2 ¹ / ₂ "	16	4"	10 ¹ / ₂ "	1 ¹ / ₄ "	2 ¹ / ₂ " I.D.	16	2"	ZE040025
4" x 3"	16	4"	9 ¹ / ₄ "	1 ¹ / ₄ "	3" I.D.	16	2"	ZE040030
4" x 3 ¹ / ₂ "	16	4"	6"	1 ¹ / ₄ "	3 ¹ / ₂ " I.D.	16	1 ¹ / ₂ "	ZE040035
5" x 2"	14	5"	19 ¹ / ₄ "	1 ¹ / ₄ "	2" I.D.	16	2 ³ / ₄ "	ZE050020
5" x 2 ¹ / ₈ "	14	5"	19 ¹ / ₄ "	1 ¹ / ₄ "	2 ¹ / ₈ " I.D.	16	2 ³ / ₄ "	ZE050021
5" x 2 ¹ / ₂ "	14	5"	17 ¹ / ₂ "	1 ¹ / ₄ "	2 ¹ / ₂ " I.D.	16	2 ³ / ₄ "	ZE050025
5" x 3"	14	5"	15"	1 ¹ / ₄ "	3" I.D.	16	2 ³ / ₄ "	ZE050030
5" x 3 ¹ / ₂ "	14	5"	12 ¹ / ₂ "	1 ¹ / ₄ "	3 ¹ / ₂ " I.D.	16	2 ³ / ₄ "	ZE050035
5" x 4"	16	5"	8"	1 ¹ / ₄ "	4" I.D.	16	1 ³ / ₄ "	ZE050040
6" x 2"	14	6"	24 ³ / ₄ "	1 ¹ / ₄ "	2" I.D.	16	3 ¹ / ₄ "	ZE060020
6" x 2 ¹ / ₈ "	14	6"	24 ³ / ₄ "	1 ¹ / ₄ "	2 ¹ / ₈ " I.D.	16	3 ¹ / ₄ "	ZE060021
6" x 2 ¹ / ₂ "	14	6"	23"	1 ¹ / ₄ "	2 ¹ / ₂ " I.D.	16	3 ¹ / ₄ "	ZE060025
6" x 3"	14	6"	20 ¹ / ₂ "	1 ¹ / ₄ "	3" I.D.	16	3 ¹ / ₄ "	ZE060030
6" x 3 ¹ / ₂ "	14	6"	18"	1 ¹ / ₄ "	3 ¹ / ₂ " I.D.	16	3 ¹ / ₄ "	ZE060035
6" x 4"	14	6"	15 ³ / ₄ "	1 ¹ / ₄ "	4" I.D.	16	3 ¹ / ₄ "	ZE060040
6" x 5"	14	6"	10"	1 ¹ / ₂ "	5" I.D.	14	1 ³ / ₄ "	ZE060050
8" x 4"	14	8"	26 ¹ / ₄ "	1 ¹ / ₄ "	4" I.D.	16	4 ¹ / ₄ "	ZE080040
8" x 5"	14	8"	21 ⁷ / ₈ "	1 ¹ / ₂ "	5" I.D.	14	4 ¹ / ₄ "	ZE080050
8" x 6"	14	8"	17 ¹ / ₂ "	1 ¹ / ₂ "	6" I.D.	14	3 ⁵ / ₈ "	ZE080060
10" x 6"	12	10"	28 ¹ / ₂ "	1 ¹ / ₂ "	6" I.D.	14	5 ¹ / ₄ "	ZE100060
10" x 8"	12	10"	18 ¹ / ₄ "	2 ¹ / ₂ "	8" O.D.	14	5 ¹ / ₄ "	ZE100080
12" x 8"	12	12"	29 ¹ / ₄ "	2 ¹ / ₂ "	8" O.D.	14	6 ¹ / ₄ "	ZE120080
12" x 10"	12	12"	19 ³ / ₄ "	3"	10" O.D.	12	6 ¹ / ₄ "	ZE120100
14" x 10"	12	14"	30"	3"	10" O.D.	12	7 ¹ / ₄ "	ZE140100
14" x 12"	12	14"	20"	4"	12" O.D.	12	7 ¹ / ₄ "	ZE140120

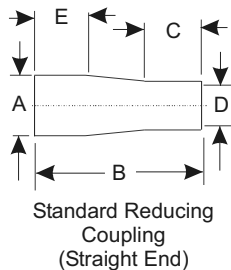
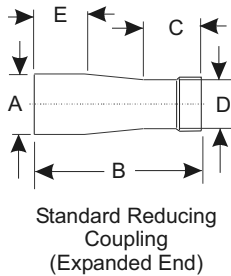

Legend:

O.D. : Outside Diameter
 ID.: Inside Diameter
 All reference dimensions are nominal.

Expanded ends standard through 6" size (on small end of reducer).

COMPRESSION COUPLINGS

(Zinc Coated Galvanized)

AVAILABLE:

- Stainless & aluminum compression couplings • 2" through 14" available
- Standard coupling includes black neoprene liner & stainless steel grounding strap
- Other gaskets are available: white nitrile, red rubber, silicone, EPDM and viton
- Protectors are available
- Stainless steel gasket protectors are available
- Different compression coupling lengths are available (4" to 12" in length depending on coupling size)
- Different number of bolts are available (2 to 5 bolts depending on coupling size)

A OD	NO. BOLT	GASKET	B Length	PART NO. (MTF-CCO)
2"	2	BLACK	6"	Z0200000
2 ¹ / ₈ "	3	BLACK	4"	Z0210000
2 ¹ / ₂ "	3	BLACK	4"	Z0250000
3"	3	BLACK	4"	Z0300000
3 ¹ / ₂ "	3	BLACK	4"	Z0350000
4"	3	BLACK	4"	Z0400000
5"	3	BLACK	6"	Z0500000
6"	3	BLACK	6"	Z0600000
8"	3	BLACK	6"	Z0800000
10"	3	BLACK	8"	Z1000000
12"	3	BLACK	8"	Z1200000
14"	4	BLACK	10"	Z1400000

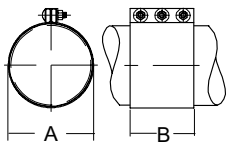

Compression Coupling

NOTES: For couplings 1¹/₄" through 2⁷/₈" OD the bolt size is 1/2" x 2"
 For couplings 3" through 7¹/₂" OD the bolt size is 5/8" x 2¹/₄"
 For couplings 8" through 14" OD the bolt size is 3/4" x 3"
 Joining methods are for use in low pressure (under 15 PSIG) systems

Legend:

O.D.: Outside Diameter
 ID.: Inside Diameter
 Length: Length of coupling
 All reference dimensions are nominal.

SLIP COUPLINGS (Zinc Coated Galvanized)

AVAILABLE:

- Carbon, stainless and aluminum reducer couplings
- Wall thickness: 16, 14, 12 gauge
- 2" through 14" available
- Slotted joining method also available

SIZE	A ID	B Length	GA	PART NO. (MTF-SC1)
2"	2"		16	Z0200000
2 ¹ / ₈ "	2 ¹ / ₈ "	3"	16	Z0210000
2 ¹ / ₂ "	2 ¹ / ₂ "	3 ¹ / ₂ "	16	Z0250000
3"	3"	4"	16	Z0300000
3 ¹ / ₂ "	3 ¹ / ₂ "	4 ¹ / ₂ "	16	Z0350000
4"	4"	5"	16	Z0400000
5"	5"	6"	14	Z0500000
6"	6"	7"	14	Z0600000
8"	8"	8"	14	Z0800000
10"	10"	10"	12	Z1000000
12"	12"	12"	12	Z1200000
14"	14"	14"	12	Z1400000

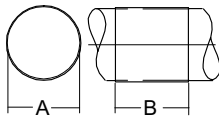

Slip Coupling

* Joining methods are for use in low pressure (under 15 PSIG) systems

Legend:

SHRINK TAPE

AVAILABLE:

- Shrink sleeves also available

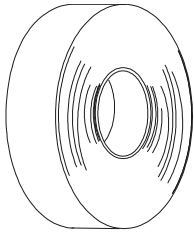

Shrink Tape
by the Roll

SIZE	ROLL LENGTH	PART NO. (HAR)
2"	82'	CAN-AT050250
4"	82'	CAN-AT100250
6"	82'	CAN-AT150250

NOTES: Joining methods are for use in low pressure (under 15 PSIG) systems
Shrink tape needs to be secured with 2" fiberglass tape (HAR-GRM-GL3652X5)

HEAT SHRINK TAPE SIZE AND LENGTH TABLE

PIPE SIZE	LENGTH	FITTINGS	COUPLINGS
2"	8 1/2"	2" Tape	4" Tape
2 1/8"		2" Tape	4" Tape
2 1/2"	10"	2" Tape	4" Tape
3"	11"	2" Tape	4" Tape
3 1/2"	13"	2" Tape	4" Tape
4"	15"	4" Tape	4" Tape
5"	18"	4" Tape	6" Tape
6"	21"	4" Tape	6" Tape
8"		Compression coupling or Shrink Sleeve supplied	
10"		Compression coupling or Shrink Sleeve supplied	
12"		Compression coupling or Shrink Sleeve supplied	
14"		Compression coupling or Shrink Sleeve supplied	

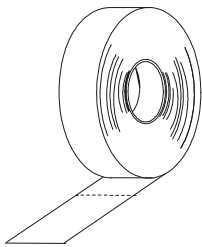

Shrink Tape
by the Piece

SHRINK SLEEVES

TUBE OD SIZE	LENGTH	PART NO. (MTF-SSL)
2" to 2 1/8"	4"	00210000
2" to 2 1/2"	4"	00250000
2" to 2 1/2"	6"	00250006
2 1/2" to 3"	4"	00300000
2 1/2" to 3"	6"	00300006
3 1/2" to 4"	4"	00400000
5"	4"	00500000
6"	4"	00600000
8"	9"	00800000
10"	9"	01000000
12"	9"	01200000

Legend:

STANDARD MALE ADAPTERS

(Zinc Coated Galvanized)

AVAILABLE:

- Carbon, stainless and aluminum male adapters
- Reducing male adapters available upon request
- 2" through 12" available
- Wall thickness: 16, 14, 12, 11 gauge

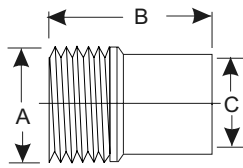

Male Adapter

SIZE	GA	A MNPT	B	C PIPE OD	PART NO. (MTF-MAA)
2" to 2"	16	2"	6"	2"	ZE020020
2" to 2 ¹ / ₈ "	16	2"	6"	2 ¹ / ₈ "	ZE020021
2 ¹ / ₂ " to 2 ¹ / ₂ "	16	2 ¹ / ₂ "	6"	2 ¹ / ₂ "	ZE025025
3" to 3"	16	3"	6"	3"	ZE030030
3 ¹ / ₂ " to 3 ¹ / ₂ "	16	3 ¹ / ₂ "	6"	3 ¹ / ₂ "	ZE035035
4" to 4"	16	4"	6"	4"	ZE040040
5" to 5"	14	5"	6 ¹ / ₂ "	5"	ZE050050
6" to 6"	14	6"	7"	6"	ZE060060
8" to 8"	14	8"	8"	8"	ZE080080
10" to 10"	12	10"	8 ¹ / ₂ "	10"	ZE100100
12" to 12"	12	12"	9"	12"	ZE120120

MALE ADAPTERS

(Zinc Coated Galvanized)

AVAILABLE:

- Carbon, stainless and aluminum male adapters
- 2¹/₈"

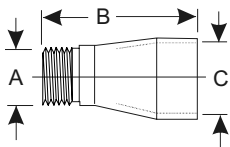

Male Adapter

SIZE	A MNPT	B	D*	C ID	C OD	PART NO. (MTF-MAT)
2 ¹ / ₈ " x 1 ¹ / ₄ "	1 ¹ / ₄ "	5 ³ / ₄ "	-	-	2 ¹ / ₈ "	ZE021114
2 ¹ / ₈ " x 1 ¹ / ₂ "	1 ¹ / ₂ "	5 ³ / ₄ "	-	-	2 ¹ / ₈ "	ZE021112
2 ¹ / ₈ " x 1 ¹ / ₄ "	1 ¹ / ₄ "	5 ³ / ₄ "	1 ¹ / ₄ "*	2 ¹ / ₈ "	-	ZEX21114
2 ¹ / ₈ " x 1 ¹ / ₂ "	1 ¹ / ₂ "	5 ³ / ₄ "	1 ¹ / ₄ "*	2 ¹ / ₈ "	-	ZEX21112

* Expansion depth

Legend:

I.D. : Inside Diameter
 O.D. : Outside Diameter
 All reference dimensions
 are nominal.

MALE ADAPTERS EXPANDED

AVAILABLE:

- Carbon, stainless and aluminum male adapters
- Reducing male adapters available upon request
- 2" through 6"
- Wall thickness: 16, 14, 12 gauge

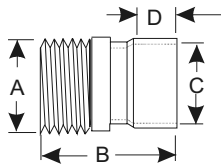

Male Adapter
Expanded

SIZE	GA	A MNPT	C	D	E ID	PART NO. (MTF-MAP)
2" to 2"	16	2"	4"	1 ¹ / ₈ "	2"	ZE020020
2" to 2 ¹ / ₈ "	16	2"	4"	1 ¹ / ₄ "	2 ¹ / ₈ "	ZE021020
2 ¹ / ₂ " to 2 ¹ / ₂ "	16	2 ¹ / ₂ "	4"	1 ¹ / ₄ "	2 ¹ / ₂ "	ZE025025
3" to 3"	16	3"	4 ³ / ₄ "	1 ¹ / ₄ "	3"	ZE030030
3 ¹ / ₂ " to 3 ¹ / ₂ "	16	3 ¹ / ₂ "	4 ³ / ₄ "	1 ¹ / ₄ "	3 ¹ / ₂ "	ZE035035
4" to 4"	16	4"	4 ³ / ₄ "	1 ¹ / ₄ "	4"	ZE040040
5" to 5"	14	5"	5"	1 ¹ / ₂ "	5"	ZE050050
6" to 6"	14	6"	5 ¹ / ₄ "	1 ¹ / ₂ "	6"	ZE060060

Legend:

STANDARD FEMALE ADAPTERS

(Zinc Coated Galvanized)

AVAILABLE:

- Carbon, stainless and aluminum female adapters
- Reducing female adaptors available upon request
- 2" through 12" available
- Wall thickness: 16, 14, 12, 11 gauge

SIZE	GA	A FNPT	B	C PIPE OD	PART NO. (MTF-FAA)
2" to 2"	16	2"	6"	2"	ZE020020
2" to 2 ¹ / ₈ "	16	2"	6"	2 ¹ / ₈ "	ZE020021
2 ¹ / ₂ " to 2 ¹ / ₂ "	16	2 ¹ / ₂ "	6"	2 ¹ / ₂ "	ZE025025
3" to 3"	16	3"	6"	3"	ZE030030
3 ¹ / ₂ " to 3 ¹ / ₂ "	16	3 ¹ / ₂ "	6"	3 ¹ / ₂ "	ZE035035
4" to 4"	16	4"	6 ¹ / ₂ "	4"	ZE040040
5" to 5"	14	5"	6 ³ / ₄ "	5"	ZE050050
6" to 6"	14	6"	7"	6"	ZE060060
8" to 8"	14	8"	9"	8"	ZE080080
10" to 10"	12	10"	11"	10"	ZE100100
12" to 12"	12	12"	13"	12"	ZE120120

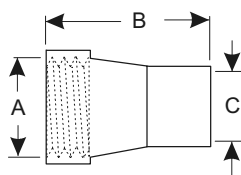

Female Adapter

FEMALE ADAPTERS EXPANDED

(Zinc Coated Galvanized)

AVAILABLE:

- Carbon, stainless and aluminum female adapters
- Reducing female adaptors available upon request
- 2" through 6"
- Wall thickness: 16, 14, 12 gauge

SIZE	GA	A FNPT	B	C	D PIPE OD	PART NO. (MTF-FAP)
2" to 2"	16	2"	4"	1 ¹ / ₈ "	2"	ZE020020
2" to 2 ¹ / ₈ "	16	2"	4"	1 ¹ / ₄ "	2 ¹ / ₈ "	ZE021020
2 ¹ / ₂ " to 2 ¹ / ₂ "	16	2 ¹ / ₂ "	5"	1 ¹ / ₄ "	2 ¹ / ₂ "	ZE025025
3" to 3"	16	3"	5 ¹ / ₄ "	1 ¹ / ₄ "	3"	ZE030030
3 ¹ / ₂ " to 3 ¹ / ₂ "	16	3 ¹ / ₂ "	5 ¹ / ₂ "	1 ¹ / ₄ "	3 ¹ / ₂ "	ZE035035
4" to 4"	16	4"	6 ¹ / ₂ "	1 ¹ / ₄ "	4"	ZE040040
5" to 5"	14	5"	6 ³ / ₄ "	1 ¹ / ₂ "	5"	ZE050050
6" to 6"	14	6"	7"	1 ¹ / ₂ "	6"	ZE060060

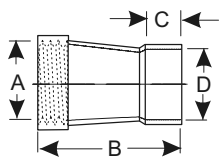

Female Adapter Expanded

Legend:

O.D. : Outside Diameter
All reference dimensions are nominal.

90° ADAPTER ELBOW

(Zinc)

AVAILABLE:

- Cast gray iron, nickel plated and cast aluminum 90° adapter elbows
- 2 1/8" through 2" available

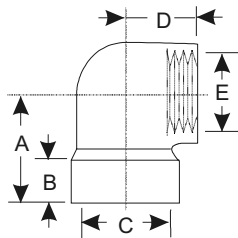

90° Adapter Elbow

SIZE	A	B	C ID	D	E FNPT	PART NO. (MTF-FAE)
------	---	---	---------	---	-----------	-----------------------

2" to 2"	2 ⁹ / ₁₆ "	1 ¹ / ₁₆ "	2 ¹ / ₈ "	1 ⁵ / ₈ "	2"	ZE020020
2 1/8" to 2"	2 ⁹ / ₁₆ "	1 ¹ / ₁₆ "	2 ¹ / ₈ "	1 ⁵ / ₈ "	2"	ZE021020

ADAPTER TEES

(Zinc)

AVAILABLE:

- Cast gray iron, nickel plated and cast aluminum adapter tees
- 2 1/8" through 4" available • 11 gauge adapters available

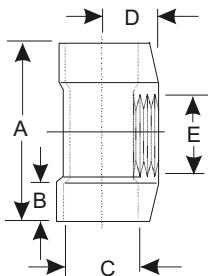

Adapter Tee

SIZE	A	B	C ID	D	E FNPT	PART NO. (MTF-TEE)
------	---	---	---------	---	-----------	-----------------------

2 1/8" to 2"	4 ¹³ / ₁₆ "	1 ¹ / ₁₆ "	2 ¹ / ₈ "	1 ⁹ / ₁₆ "	2"	ZE021020
2 1/2" to 2"	6 ¹ / ₂ "	1 ¹ / ₄ "	2 ¹ / ₂ "	2 ¹ / ₈ "	2"	ZE025020
3" to 2"	6 ¹ / ₂ "	1 ¹ / ₄ "	3"	2 ³ / ₄ "	2"	ZE030020
3 1/2" to 2"	6 ⁷ / ₈ "	1 ¹ / ₄ "	3 ¹ / ₂ "	3 ⁷ / ₁₆ "	2"	ZE035020
4" to 2"	6 ⁷ / ₈ "	1 ¹ / ₄ "	4"	3 ⁷ / ₁₆ "	2"	ZE040020

* Not available in 11 gauge

MALE ADAPTER NIPPLE

(Zinc Coated Galvanized)

AVAILABLE:

- Carbon, stainless and aluminum male adapter nipples
- 2 1/8"

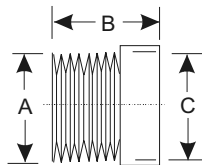

Male Adapter Nipple

SIZE	A MNPT	B	C ID	PART NO. (MTF-NIP)
------	-----------	---	---------	-----------------------

2 1/8"	2"	2"	2 1/8"	ZE021000
--------	----	----	--------	----------

Legend:

I.D. : Inside Diameter
All reference dimensions
are nominal.

FEMALE REDUCING ADAPTER

(Zinc Coated Galvanized)

AVAILABLE:

- Carbon, stainless and aluminum female reducing adapters • 2" through 2 1/2"
- Wall thickness: 16 gauge

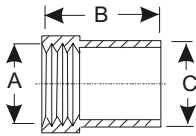

Female Reducing Adapter

SIZE	GA	A FNPT	B	C OD	PART NO. (MTF-FA)
2" to 2 1/2"	16	2"	4 1/4"	2 1/2"	ZE020025

FEMALE REDUCING ADAPTER EXPANDED

AVAILABLE:

- 2" through 2 1/2" • Wall thickness: 16 gauge

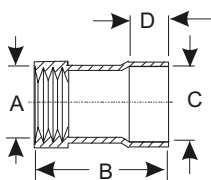

Female Reducing Adapter Expanded

SIZE	GA	A FNPT	B	C ID	D	PART NO. (MTF-FAB)
2" to 2 1/2"	16	2"	4 1/4"	2 1/2"	1 1/4"	ZE020025

45° FEMALE ADAPTER ELBOW

(Zinc Coated Galvanized)

AVAILABLE:

- Carbon, stainless and aluminum 45° Female adapter elbows • 2 1/8" to 2 1/2" OD
- Wall thickness: 16, (11 gauge available in straight ends only)

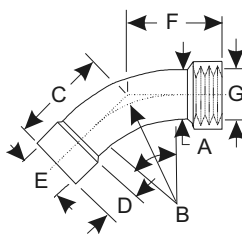

45° Female Adapter Elbow

SIZE	A OD	GA	B	C	D	E ID	F	L FNPT	PART NO. (MTF-FA4)
2 1/8" to 2"	2 1/8"	16	5"	4 1/16"	1 1/4"	2 1/8"	4 1/16"	2"	ZE021020
2 1/2" to 2"	2 1/2"	16	6"	4 1/2"	1 1/4"	2 1/2"	4 1/2"	2"	ZE025020
2 1/2" to 2 1/2"	2 1/2"	16	6"	4 1/2"	1 1/4"	2 1/2"	4 1/2"	2 1/2"	ZE025025

Legend:

O.D. : Outside Diameter
 I.D. : Inside Diameter
 All reference dimensions are nominal.

THREADED INLET VALVES

(Zinc Coated Galvanized)



Threaded Inlet Valve

AVAILABLE:

- Stainless steel and nickel plated threaded inlet valves

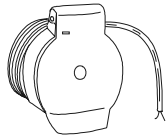

Threaded Inlet Valve with Low Voltage Switch

	BORE	MNPT	LOW VOLT. SWITCH	PART NO. (MTF-INV)
	1.5"	2"	With	ZP20150S
	1.5"	2"	Without	ZP20150N
	1.8"	2"	With	ZP20180S
	1.8"	2"	Without	ZP20180N
	2"	2"	With	ZP20200S
	2"	2"	Without	ZP20200N

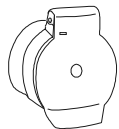

Inlet Valve

INLET VALVES

(Zinc Coated Galvanized)

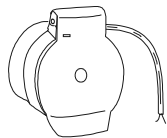

Inlet Valve with Low Voltage Switch

	BORE	ID	LOW VOLT. SWITCH	PART NO. (MTF-INV)
	1 1/2"	2"	With	ZE20150S
	1 1/2"	2"	Without	ZE20150N
	1 3/4"	2"	With	ZE20170S
	1 3/4"	2"	Without	ZE20170N

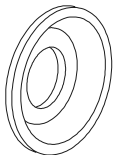

Escutcheon Plate

ESCUTCHEON PLATES

(Zinc Coated Galvanized)

AVAILABLE:

- * Stainless steel and nickel plated escutcheon plates

PART NO. MTF-INV-EPALLHP0

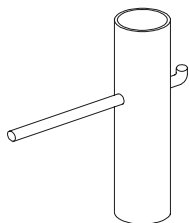

Wrench

WRENCH

PART NO. MTF-INV-EPVW1500

Legend:

I.D. : Inside Diameter
All reference dimensions are nominal.

WORK STATIONS – HEAD ONLY

(Zinc Coated Galvanized)

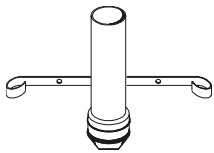

Single Hanging

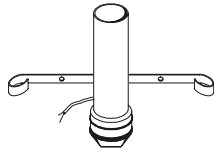

Single Hanging with Low Voltage Switch

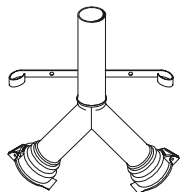

Double Hanging

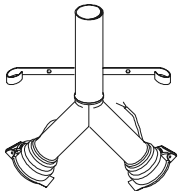

Double Hanging with Low Voltage Switch

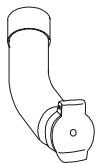

Wall Hanging

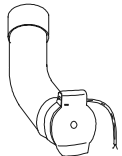

Wall Hanging with Low Voltage Switch

	HEAD	BORE(S)	ID	LOW VOLT. SWITCH	MOUNTING	PART NO. (SYS-03H)
	Single	1 1/2"	2"	With	Hanging	50014HWS
	Single	1 1/2"	2"	Without	Hanging	50014HNS
	Single	1 1/2"	2"	With	Wall Mount	50014WWS
	Single	1 1/2"	2"	Without	Wall Mount	50014WNS
	Double	1 1/2"	2"	With	Hanging/Wall Mount	55014HWS
	Double	1 1/2"	2"	Without	Hanging/Wall Mount	55014WNS
	Single	1 3/4"	2"	With	Hanging	50012HWS
	Single	1 3/4"	2"	Without	Hanging	50012HNS
	Single	1 3/4"	2"	With	Wall Mount	50012WWS
	Single	1 3/4"	2"	Without	Wall Mount	50012WNS
	Double	1 3/4"	2"	With	Hanging/Wall Mount	55012HWS
	Double	1 3/4"	2"	Without	Hanging/Wall Mount	55012HNS

Legend:

I.D. : Inside Diameter
All reference dimensions are nominal.

TUBE PLUGS

- Wall thickness: 16, 14, 12 gauge (available in 11 gauge)
- 2" to 14" OD/ID

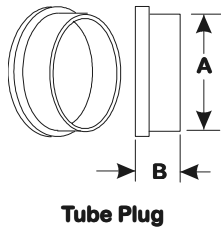

SIZE	A OD/ID	GA	B	PART NO. (MTF-TPO)
2"	2" OD	16	1 ³ / ₈ "	ZS020000
2 ¹ / ₂ "	2 ¹ / ₈ " OD	16	1 ³ / ₈ "	ZS021000
3"	3" OD	16	1 ³ / ₈ "	ZS030000
3 ¹ / ₂ "	3 ¹ / ₂ " OD	16	1 ³ / ₈ "	ZS035000
4"	4" OD	16	1 ³ / ₈ "	ZS040000
5"	5" OD	14	1 ⁵ / ₈ "	ZS050000
6"	6" OD	14	1 ⁵ / ₈ "	ZS060000
8"	8" ID	14	1 ³ / ₄ "	ZS080000
10"	10" ID	12	2"	ZS100000

TUBE HANGERS

(Zinc Coated Galvanized)

AVAILABLE:

- Wall thickness: 16 gauge
- 2¹/₈" to 14"

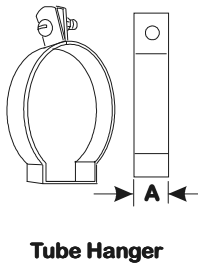

SIZE	A ID	GA	PART NO. (HAR)
2"	2"	16	TOR-04HANGER
2 ¹ / ₈ "	2 ¹ / ₈ "	16	TOR-04HANGER
2 ¹ / ₂ "	2 ¹ / ₂ "	16	TOR-05HANGER
3"	3"	16	TOR-06HANGER
3 ¹ / ₂ "	3 ¹ / ₂ "	16	TOR-07HANGER
4"	4"	16	TOR-08HANGER
5"	5"	16	GRI-30182500
6"	6"	16	GRI-30184100
8"	8"	16	GRI-30188200
10"	10"	16	GRI-G260B100
12"	12"	16	GRI-G260B120
14"	14"	16	GRI-G260B140

NOTE: Tube hangers include nuts and bolts





Legend:

O.D. : Outside Diameter
 I.D. : Inside Diameter
 All reference dimensions
 are nominal.

INSTALLATION COMPONENTS

Note: If you are searching for a particular installation component that is not listed below, please call at 1-800-265-3878 and we will be glad to help find whatever you are looking for.



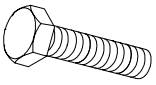

Note: All 100 piece packages can be purchased in specific quantities

	DESCRIPTION	SIZE	MATERIAL	PKGD.	PART NO.
 Hex Nut	Hex Concrete Screw	1/4" x 1 3/4"	Zinc	100 pc.	HAR-CON-SCH14134
		1/4" x 2 3/4"	Zinc	100 pc.	HAR-CON-SCH14234
 Lock Washer	HexTek Screw	1/4" x 3/4"	Zinc	100 pc.	HAR-CON-1434HTK0
		1/4" x 1"	Zinc	100 pc.	HAR-CON-141HTK00
 Nylon Insert Hex Nut	Hex Nut	1/4"	Zinc	100 pc.	HAR-CON-14HNP000
		3/8"	Zinc	100 pc.	HAR-CON-38HNP000
		1/2"	Zinc	100 pc.	HAR-CON-12HNP000
	Pantek Screw	#8 x 1/2"	Zinc	100 pc.	HAR-CON-812PTK00
 Threaded Rod	Nylon Insert Lock Nut	1/4"	Zinc	100 pc.	HAR-CON-14LHNP00
 Hex Head Screw	Flat Washer	1/4"	Zinc	100 pc.	HAR-CON-14FWP000
		3/8"	Zinc	100 pc.	HAR-CON-38FWP000
		1/2"	Zinc	100 pc.	HAR-CON-12FWP000
Hex Head Screw	Split Lock Washer	1/4"	Zinc	100 pc.	HAR-CON-14LWP000
		3/8"	Zinc	100 pc.	HAR-CON-38LWP000
		1/2"	Zinc	100 pc.	HAR-CON-12LWP000
Hex Bolt		1/4" x 3/4"	Zinc	100 pc.	HAR-CON-1434HBP0
		3/8" x 1 1/4"	Zinc	100 pc.	HAR-CON-38114HBP
		(3/8" Drop-in) 1/2" x 1 1/4"	Zinc	100 pc.	HAR-CON-12114HBP
		(1/2" Drop-in) 1/2" x 1 1/2"	Zinc	100 pc.	HAR-CON-12112HBP
		(Adaptor flange to muffler) 1/2" x 2 1/2"	Zinc	100 pc.	HAR-CON-12212HBP
		(Mount pump)			
	Threaded Rod	3/8" x 10'	Zinc	each	HAR-ATR-EGP03716
	Round Head Machine Screw (For hangers 2" thru 8" Dia.)	1/4" x 2"	Zinc	100 pc.	HAR-CON-142RHMS0
Legend:	Beam Clamp	3/8"	Black Steel	each	HAR-GRI-00906300
	Ceiling Flange	3/8"	Black Steel	each	HAR-GRI-01560700
	Side Beam Bracket	3/8"	Black Steel	each	HAR-GRI-G2073800

INSTALLATION COMPONENTS CONTINUED

Note: If you are searching for a particular installation component that is not listed below, please call at 1-800-265-3878 and we will be glad to help find whatever you are looking for.

Note: All 100 piece packages can be purchased in specific quantities

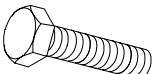
	DESCRIPTION	SIZE	MATERIAL	PKGD.	PART NO.
 Hex Nut	Wood Lag Screw	1/4" x 1"	Zinc	100 pc.	HAR-CON-141LB000
		1/4" x 1 1/2"	Zinc	100 pc.	HAR-CON-14112LBP
 Lock Washer	Drop-In Anchor	3/8"	Zinc	Each	HAR-CON-IPA38120
		1/2"	Zinc	Each	HAR-CON-IPA12580
 Nylon Insert Hex Nut	Drop-In Setting Tool	3/8"	Zinc	Each	HAR-CON-IPA38120
		1/2"	Zinc	Each	HAR-CON-IPA12580
 Threaded Rod	Uni-Strut/U-Channel (C-Slot, 13 ga.)	1 5/8" x 10'	Zinc	Each	MSH-UD0-0P27C100
 Hex Head Screw	90° Angle Fitting for Uni-Strut/U-Channel	1-5/8" x 4"	Zinc	Each	HAR-UNI-P13226CA0
	Plate Washer for Uni-Strut/U-Channel	9/16"	Zinc	Each	HAR-WFP-SQ056162
	Drop-In Setting Tool	1/2"	Zinc	100 pc.	HAR-CON-IPA12580
	E-6000 Clear Adhesive	1 Oz. Tube	Perchloroethylene	Each	HAR-ADH-E610TUBE
		2 Oz. Tube	Perchloroethylene	Each	HAR-ADH-E620TUBE
		3.7 Oz. Tube	Perchloroethylene	Each	HAR-ADH-E637TUBE
		10 Oz. Cartridge	Perchloroethylene	Each	HAR-ADH-E610CART
	Grey Low Voltage Wire 24 v. Control Wiring	2C#18	Grey	245' Roll	ELE-DMT-77151000
	Blue Ground Wire (For Hanging Drops)	14 Ga.	Blue	300 m. Roll	ELE-DEL-09190600
	Cable Tie	14"	Nylon	each	ELE-TOR-NT140000

Legend:

* Malleable Iron- Galv.
With Zinc Set Screw
and Lock Nut.
Maximum allowable
load, in top or bottom
positions, is 550 lbs