

# 15-50 hp

*Rotary Screw Compressors*



# Performance That Pays

*Welcome to Ingersoll Rand's UP-Series Rotary Air Solutions, a Higher Standard of Performance.*



# Boost Your Profitability

*Boosting Your Company's Profits Was the Main Goal That Ingersoll Rand Had in Mind When Designing the Revolutionary UP-Series Line of Integrated Rotary Screw Air Solutions.*

So how can a compressed air system help you increase profitability? The answer is really pretty simple: by ensuring that you achieve highest productivity in your shop while reducing the total costs of ownership to the absolute lowest levels.

The UP-Series is more than an integrated air system; it's a complete air solution designed to maximize the key drivers of profitability in today's business:

- Ultimate reliability
- Shop productivity
- Flexibility of operation
- Energy efficiency and savings

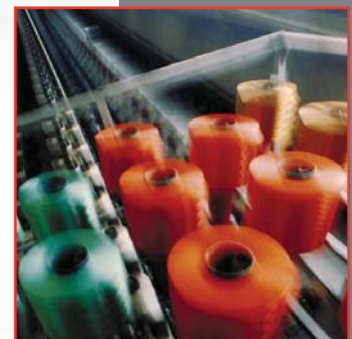

# Exceptional Value

## Ultimate Reliability

### Maximum Uptime

Ingersoll Rand is so confident in the performance of the UP-Series, that we've extended the warranty to five years.

### Fewer Connections

Smart integration eliminates leaks and pressure drops, maximizing reliability.

## Ultimate Efficiency

### More Air For Your Money

Industry-leading performance delivers more air for less horsepower, saving thousands of dollars per year on energy.

### Smart, Energy-Efficient Controls

Eliminates wasteful unloaded running by unloading rapidly and by cycling the compressor on/off when not needed.

## Ultimate Flexibility

### Compact Footprint

Receiver mounting frees up valuable floor space and reduces installation costs.

### Installation Close To Point-of-Use

Whisper-quiet operation allows for installation closer to point-of-use, reducing costs and ensuring a better, safer work environment.

## Ultimate Productivity

### Closely Maintained Pressure

Reducing discharge pressure and avoiding excessive pressure bands, increases downstream tool and equipment life.



## Innovation

### High-Efficiency Integrated Compression Module

- To provide maximum performance, efficiency and ease of service, the airend, interconnecting piping and separation system have all been integrated into one simple design. Integration of the compression module eliminates leaks and pressure losses to increase efficiency and performance.
- Service and maintenance are made extremely simple through spin-on filtration and separator cartridges.

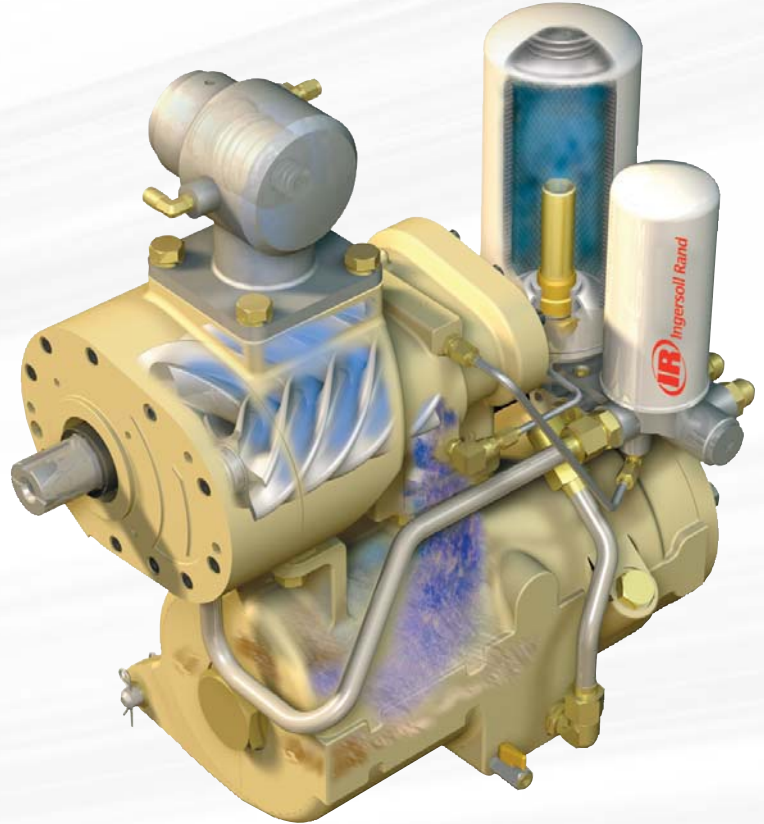

## Real World Advantages

### Whisper-Quiet Operation

Oversized, high-efficiency cooling air blower provides sound levels as low as 67 dBA.



### Poly-V Belt Drive

Premium drive system applies patented automatic tensioning to eliminate belt stretch and increase air output.



### Dual-Control Operation

Reliable and effective load/no-load control with automatic stop and restart facility for maximum flexibility.



### Advanced Cooling

A package pre-filter, efficient combination aftercooler with access to both sides for easy cleaning and top discharge to simplify ducting.



### Simple Diagnostics

Visual indication of operating status and hours run for ease of operation and reduced downtime.



### Generous Serviceability

All key maintenance components have been grouped to provide ease of serviceability.



# Integral Air Treatment for 15-30 hp

## High-Efficiency Filter Pack

### Clean Air to Drive Productivity

- Deep-bed general purpose filtration to deliver best performance, reduce pressure losses and extend operating life.
- Particulate removal to industry leading 1 micron.
- Longer element life, lower pressure drop
- Better air quality delivered to tools and equipment results in longer life.
- Prepares air for further treatment to meet specific requirements.

## Energy-Saving Refrigerated Air Dryer

### Dry Air to Drive Productivity

- High-efficiency direct expansion refrigerated dryer automatically starts with the compressor and operates continually. This operating cycle ensures immediate drying, reactive to the compressor loads. The dryer operates until the compressor unit is shut down.
- Simple coiled tube-in-tube heat exchanger is selected at this size of unit to achieve optimum performance, with low losses, high thermal efficiency and long service life.
- Highly efficient centrifugal moisture separator with timed solenoid drain valve permanently discharges condensate.
- Eliminates corrosion of piping – a cause of premature wear of tools and seals.

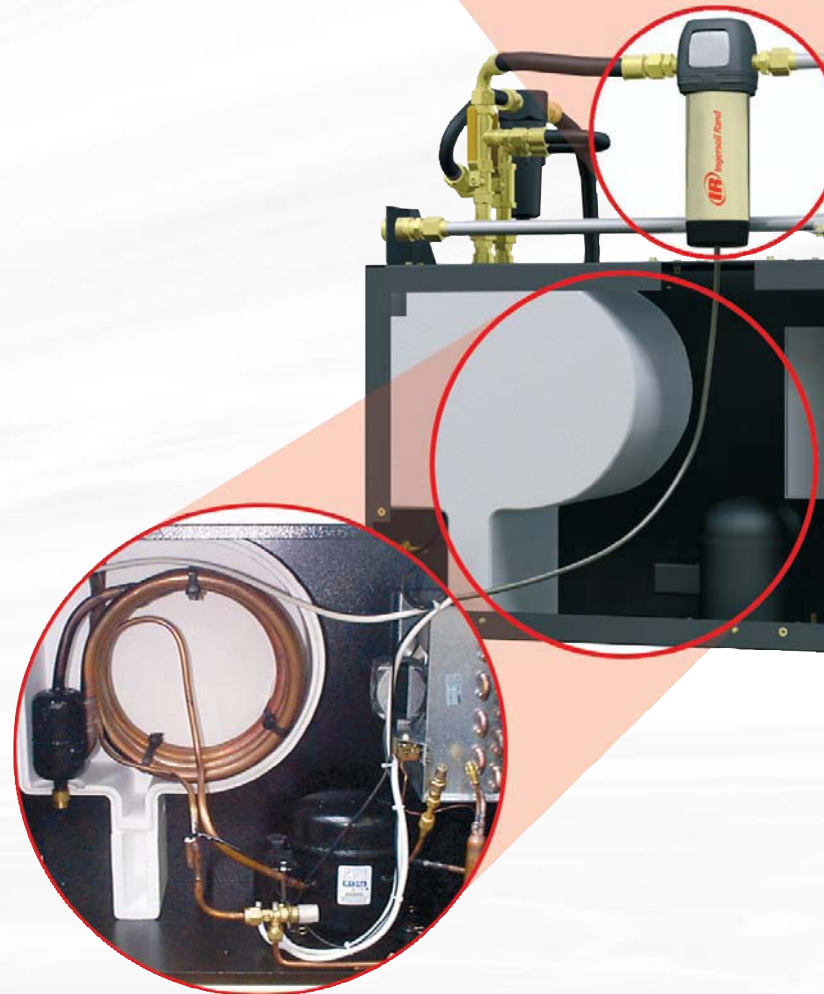

### Smart Integration for 15-30 hp

#### Advanced Packaging to Drive Reliability and Uptime

- "Dry" air receiver mounted in a compact package lowers the cost of installation (optional floor mount also available).
- Integral air cooling with separate flow paths ensure cooling is achieved 100% of time the that compressor is running.
- Easy access to all compressor and air treatment components, promoting serviceability.
- Package pre-filter for longer component life and reduced maintenance cost.
- Simplified piping eliminates potential leaks.
- Single-point condensate drain system instead of separate points reduces installation cost.
- Segregated cooling compartment provides advanced cooling flow management and reduces noise level.

### Practical Options and Kits

#### Customize Your System

- Floor mounted
- Compressor package without air treatment equipment
- Weather-resistant enclosure
- NEMA 4 package with TEFC motor
- PORO (power outage restart option) to safely restore machine following power interruption
- Frost protection (not available for units with refrigerant dryer)
- Upper range modulation control
- Sequence controllers
- Pace system pressure regulators

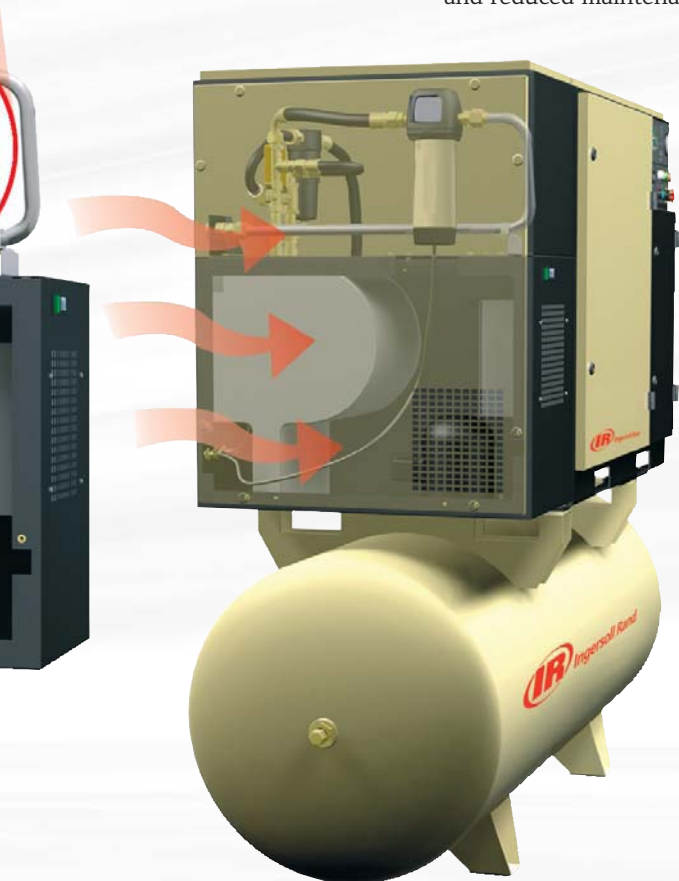

# Integral Air Treatment for 40 and 50 hp

## Modular Cross Flow Heat Exchanger

### Leading Technology Driving Efficiency

At the heart of the dryer lies the specially designed cross flow heat exchanger module, incorporating air-to-air and air-to-refrigerant heat exchangers; and a high-efficiency stainless steel de-mister condensate separator all in one compact unit.

Pre-cooling reduces the refrigeration load by as much as 60%. Air is further cooled through refrigerant heat exchange. Moisture is removed by the de-mister, close-coupled to the evaporator.

Cross flow heat exchanger incurs minimum air pressure losses while ensuring efficient water removal.

## Energy-Saving Refrigerated Air Dryer

### Dry Air to Drive Productivity

- Direct expansion – refrigeration dryer simply and reliably dries the compressed air whenever the machine is loaded.
- Composite welded aluminium heat exchanger for low losses, high thermal efficiency and long service life.
- Solenoid drain valve and high-efficiency moisture separator to permanently discharge condensate.
- Eliminates corrosion of piping – a cause of premature wear of tools and seals.

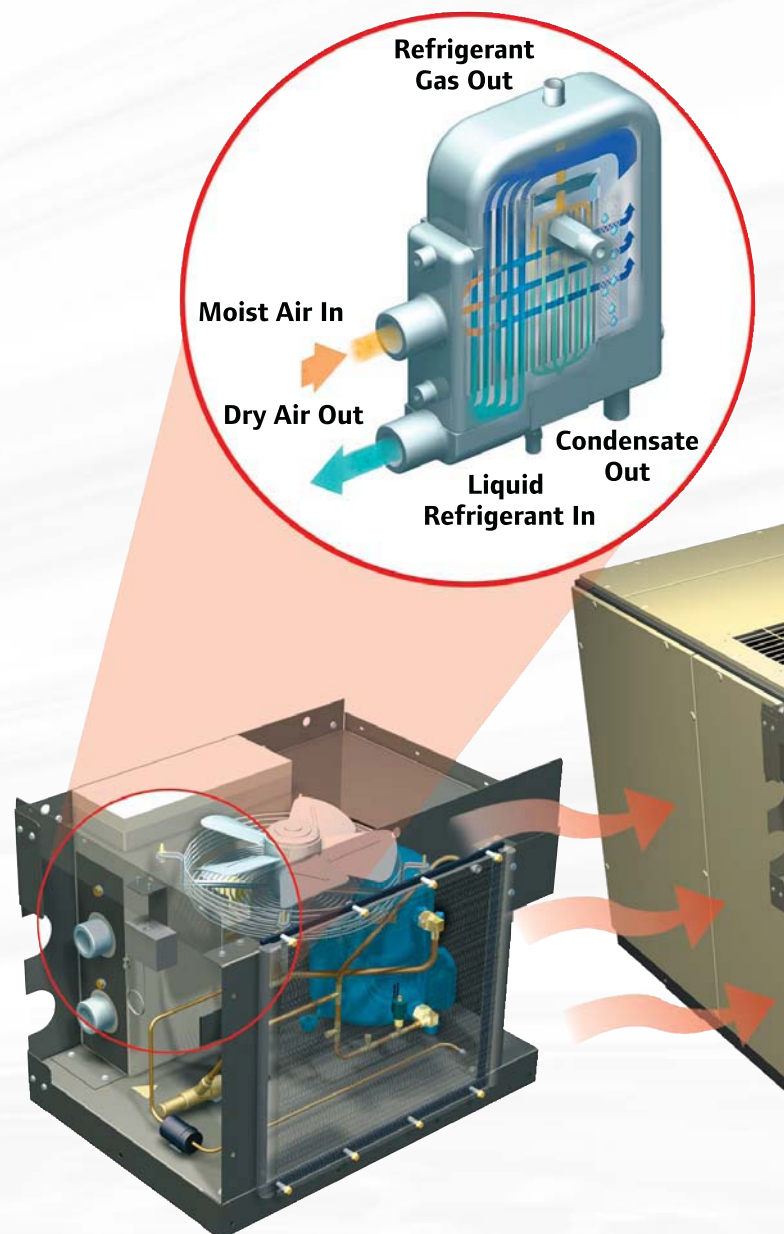

### Smart Integration for 40 and 50 hp

#### Advanced Packaging to Drive Reliability and Uptime

- Floor mounted units only (a wide range of free-standing receivers are optionally available).
- Integrally cooled dryer module with separate cooling paths to achieve best overall efficiency and ensure cooling is achieved 100% of the time that compressor is running.
- Spacious design simplifys access and promotes serviceability.
- Package pre-filter for longer cooler life and reduced maintenance costs
- Simplified piping eliminates potential leaks.
- Single-point condensate drain system.
- Optional supply without dryer installation.

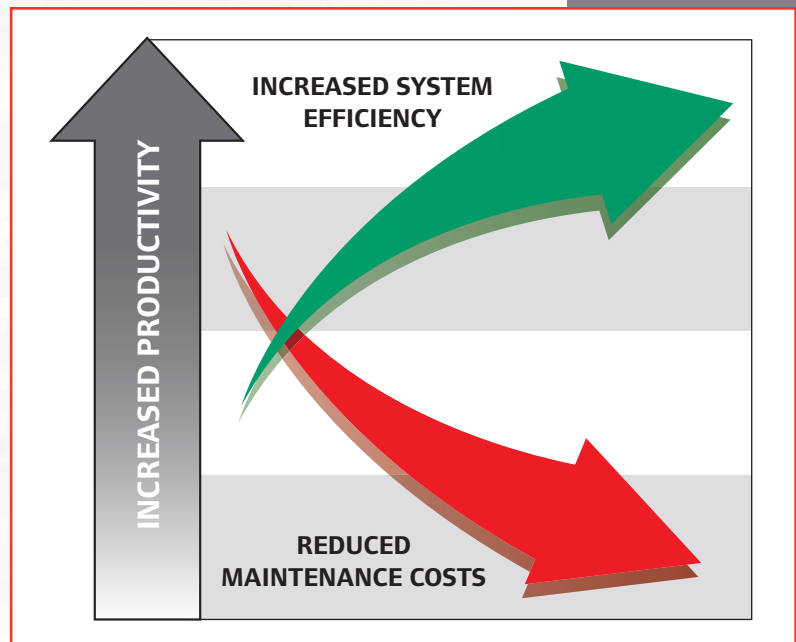

# Unsurpassed Local Customer Support

## Long-Term Value

There is more to value than simply price. The commitment of many thousands of dedicated compressed air specialists, either directly employed or members of a select market channel partnership, mean that friendly Ingersoll Rand support is close at hand. In addition to parts availability, qualified on-site service is available globally.

## Aircare Advantage

### Leading Warranty as Standard

The Ingersoll Rand UP-Series compressor comes with a 1-year inclusive warranty package with optional 5- and 7-year warranty coverages. Consult your local service provider for details.

There are options available to extend the warranty coverage and get total peace of mind with Aircare Advantage.



## Intellisys Control Option

Probably the best known name in compressor control systems, the optional Intellisys Control offers precise pressure control, energy saving functions and advanced asset protection.

## Ease of Service

Ingersoll Rand designed the UP-Series package with ease of service in mind. Spin-on filter and separator element along with 3,000/6,000/9,000 hour annual service intervals make life simple. Your Ingersoll Rand Air Solutions provider will recommend the most cost-effective maintenance program to keep your investment operating trouble-free for years.



## Ultra Plus Coolant

Save cost with the advanced synthetic compressor coolant supplied as standard. Ultra Plus coolant reduces friction and wear, has a long operating life, has simple condensate separation characteristics and is biodegradable.

*The best overall value is getting the most out of your investment. Ingersoll Rand customer support teams will help you protect your investment.*

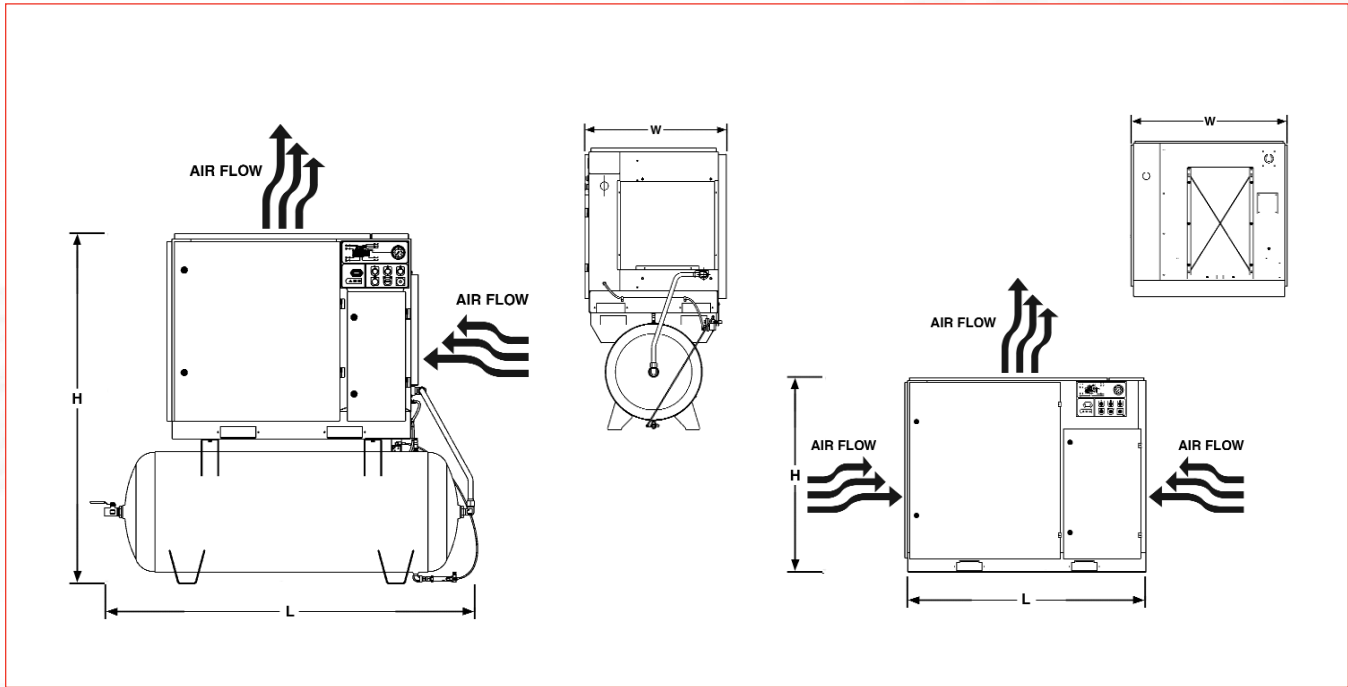

## Industry-Leading Performance

### Specifications

Model Number	hp	Kw	CAPACITY FAD		PSIG at Discharge		dBA <sup>†</sup>
			cfm	m <sup>3</sup> /min <sup>††</sup>	before dryer	after dryer	
UP6 15 125	15	11	65	1.84	125	120*	68+3
UP6 15 150	15	11	58	1.64	150	145*	68+3
UP6 20 125	20	15	83	2.35	125	120*	68+3
UP6 20 150	20	15	75	2.12	150	145*	68+3
UP6 20 200	20	15	58	1.64	200	195*	68+3
UP6 25 125	25	18.5	102	2.89	125	120*	69+3
UP6 25 150	25	18.5	92	2.61	150	145*	69+3
UP6 25 200	25	18.5	75	2.12	200	195*	69+3
UP6 30 125	30	22	125	3.54	125	120*	69+3
UP6 30 150	30	22	112	3.17	150	145*	69+3
UP6 30 200	30	22	92	2.61	200	195*	69+3
UP6 40 115	40	30	188	5.32	115	112 <sup>‡</sup>	69+3
UP6 40 125	40	30	185	5.24	125	122 <sup>‡</sup>	69+3
UP6 40 150	40	30	170	4.81	150	147 <sup>‡</sup>	69+3
UP6 40 200	40	30	143	4.05	200	N/A	69+3
UP6 50PE 115	50	37	212	6.02	115	112 <sup>‡</sup>	69+3
UP6 50PE 125	50	37	208	5.89	125	122 <sup>‡</sup>	69+3
UP6 50PE 150	50	37	201	5.70	150	147 <sup>‡</sup>	69+3
UP6 50PE 200	50	37	167	4.73	200	N/A	69+3

### Dimensions and Weights

Mounting	hp	L W H			Weight (lbs.)		
		Dimensions (in.)			wo/dryer	w/dryer	
Standard Baseplate Package	15	50.6	36.2	41.3	1,142	-	
	20	50.6	36.2	41.3	1,186	-	
	25	50.6	36.2	41.3	1,206	-	
	30	50.6	36.2	41.3	1,292	-	
	40	67.4	54.3	52.9	2,436	-	
Baseplate with Integral Air Treatment	50	67.4	54.3	52.9	2,476	-	
	15	67.0	36.2	41.3	-	1,367	
	20	67.0	36.2	41.3	-	1,411	
	25	67.0	36.2	41.3	-	1,451	
	30	67.0	36.2	41.3	-	1,537	
Tank-Mounted**	40	67.4	54.3	52.9	-	2,686	
	50	67.4	54.3	52.9	-	2,726	
	15	74.4	36.2	70.6	1,466	1,691	
	120 Gallon Receiver	20	74.4	36.2	70.6	1,510	1,735
Tank-Mounted**	25	74.4	36.2	70.6	1,530	1,775	
	30	74.4	36.2	70.6	1,616	1,861	
	240 Gallon Receiver	15	91.2	36.2	76.4	1,735	1,960
	20	91.2	36.2	76.4	1,779	2,004	
Tank-Mounted**	25	91.2	36.2	76.4	1,799	2,044	
	30	91.2	36.2	76.4	1,885	2,130	

\*Maximum discharge pressure for package, which includes moisture separator, refrigerated dryer and installation with GP filter. Filtration efficiency to 1 micron for solid particles, liquids 0.5 mg/m<sup>3</sup> W at 21 °C and condensate drains.

‡Maximum discharge pressure for package which includes moisture separator, refrigerated dryer, installation and condensate drains.

††Capacity quoted tested in accordance with ISO 1217:1996 annex C (CAGI-pneurop PN2CPT2)

\*\*Dimensions same for receiver mounted package either with or without dryer

†Sound levels per ISO 2151:2004 annex C

N/A indicates not available



Ingersoll Rand Industrial Technologies provides products, services and solutions to enhance the efficiency and productivity of our commercial, industrial and process customers. Our innovative products include air compressors, air systems components, tools, pumps, material and fluid handling systems and microturbines.

[www.ingersollrand.com](http://www.ingersollrand.com)

**Air Solutions**  
P.O. Box 1840  
800-D Beatty Street  
Davidson, NC 28036  
(704) 655-5000  
(704) 655-4039 Fax



Ingersoll Rand compressors are not designed, intended or approved for breathing air applications. Ingersoll Rand does not approve specialized equipment for breathing air applications and assumes no responsibility or liability for compressors used for breathing air service.

Nothing contained on these pages is intended to extend any warranty or representation, expressed or implied, regarding the product described herein. Any such warranties or other terms and conditions of sale of products shall be in accordance with Ingersoll Rand's standard terms and conditions of sale for such products, which are available upon request.

Product improvement is a continuing goal at Ingersoll Rand. Designs and specifications are subject to change without notice or obligation.