



*Rotary Screw Compressors*

*UP-Series 5-15 HP*



A new standard of  
**performance**

**Rotary Screw Compressors**  
**UP-Series 5-15 HP**

A new standard of  
**performance**

**Boost Your Profitability**

Boosting your company's profits was the main goal that Ingersoll-Rand had in mind when it designed the revolutionary UP-Series line of integrated rotary screw air solutions.

So how can a compressed air system help you increase profitability? The answer is really pretty simple, by ensuring that you achieve highest productivity in your shop while minimizing the total costs of ownership to the absolute lowest levels.

The UP-Series is more than an integrated air system, it's a complete air solution designed to maximize the key drivers of profitability in today's business:

- Uptime Reliability
- Shop Productivity
- Flexibility Of Operation
- Energy Efficiency & Savings

**Welcome to Ingersoll-Rand's  
UP-Series Rotary Air Solutions, a  
new standard of performance.**

Achieve  
**highest productivity**  
and  
**lowest total cost**  
of ownership

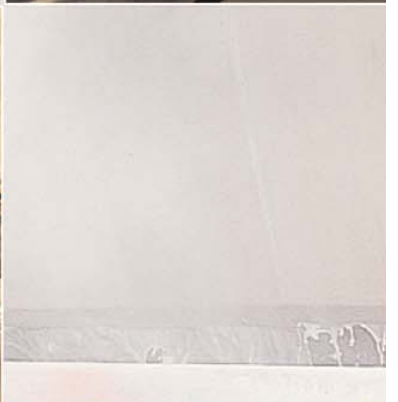

# Rotary Screw Compressors

## UP-Series 5-15 HP

# Exceptional value

### Ultimate Reliability

- **Maximum Uptime**  
Ingersoll-Rand is so confident in the performance of the UP-Series, that we've extended the warranty to 5 years.
- **70% Fewer Connections**  
Smart integration eliminates leaks and pressure drops maximizing reliability.

### Ultimate Efficiency

- **More Air For Your Money**  
Industry leading performance delivers more air for less horsepower, saving thousands of dollars per year on energy.
- **Smart, Energy Efficient Controls**  
Eliminates wasteful unloaded running by cycling the compressor on/off.

### Ultimate Flexibility

- **Compact Footprint Design**  
Small footprint frees up valuable floor space and reduces install costs.
- **Installation Close To Point-of-use**  
Whisper quiet operation allows for installation closer to point-of-use, reducing costs and ensuring a better & safer work environment.



### Ultimate Productivity

- **Closely Maintained Pressure**  
Closely maintained discharge pressure avoids excessive pressure bands & increases downstream tool and equipment life.

## Innovation

- **High Efficiency Integrated Compression Module**

To provide maximum performance, efficiency and ease of service, the airend, interconnecting piping and separation system have all been integrated into one simple design. Integration of the compression module eliminates leaks and pressure losses to increase efficiency and performance.

Service and maintenance are made extremely easy through spin-on oil and separator cartridges.

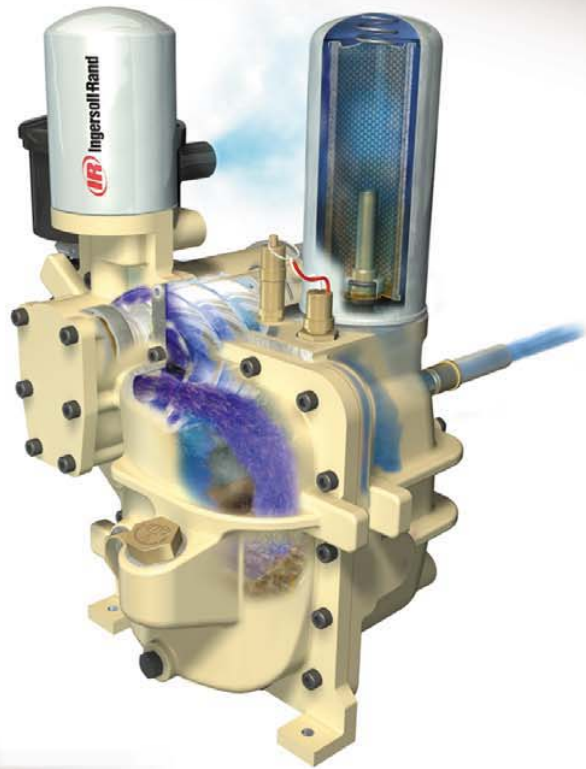

# Real world advantages

- **Whisper Quiet Operation**

Oversized, high efficiency motor mount blower. Sound levels as low as 65 dBA.



- **Poly-V Belt Drive**

Premium drive system to minimize belt stretching and increase air output.



- **Dual Control Operation**

Auto start/stop operation with constant speed control for maximum flexibility.



- **Advanced Cooling**

High efficiency, oversized combination cooler with roof mount discharge for ease of ducting.

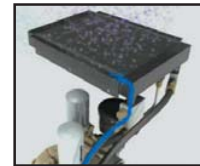

- **Simple Diagnostics**

Visual indication of operating status, hours & fault warnings for ease of operation and reduced downtime.



- **Generous Serviceability**

Spacious design for ease of serviceability.



# Rotary Screw Compressors

## UP-Series 5-15 HP

CO



### Ingersoll-Rand's Total Air System

#### The UP Series Fully Integrated Air System

*The right choice to maximize  
productivity*

At the same time as eliminating your task of selecting separate components, and reducing the extensive space requirements of the traditional compressed air system, the Total Air System  will provide your business with maximum efficiency, reliability, flexibility, and productivity.

#### Smart Integration

*A revolutionary advancement*

Going far beyond combining the compressor, dryer and filters in one package, smart integration also:

- Eliminates vulnerable interconnecting piping.
- Minimizes pressure losses and drops.
- Integrates the compressor, dryer and controls into an energy reducing optimized system.
- Incorporates the entire supply side system into one whisper quiet package enabling installation virtually anywhere.
- Provides generous space to promote cooling and allow unobstructed service.



The high efficiency

# compressor room

...without the need for an actual room

## Dry & Clean Compressed Air *The right air quality to do the job*

All  packages come fully equipped with an integral, energy saving air treatment center including high performance air dryer and filtration pack to remove water, oil and particles from the air stream.



All components are perfectly matched to deliver the right air quality to increase air powered tool and system equipment life.

## Lifetime benefits

Benefits are virtually endless...

- ✓ Plug-and-play simplicity – eliminates the number one cause of failure in air systems – incorrect sizing and installation.
- ✓ Virtually no install costs – eliminates 80% of install time, material & costs.
- ✓ Integral packaging saves valuable floor space for other uses.

## High Efficiency Components *Setting the standard in system design*

The UP Series  incorporates only the highest quality components to ensure that both system efficiency and productivity are maximized. A high efficiency compressor room without the hassle, complexity and costs of the traditional compressor room.  packages come fully equipped with...

- High Efficiency rotary screw air compressor.
- Energy Saving, Cycling Refrigerated Air Dryer.
- High Efficiency Coalescing filter.
- High Efficiency Particulate filter.
- Integral air receiver storage tank.
- Integrated compressor and dryer controls.
- Low pressure drop piping.
- High Efficiency moisture separator.
- Whisper quiet, low sound operation.

- ✓ Lifetime power savings through high efficient components.
- ✓ Increased productivity through better air quality – elimination of water and corrosion results in extended tool & equipment life.
- ✓ Whisper quiet operation enables installation closer to point-of-use which can eliminate hundreds of feet in piping and costly pressure drops.

# Rotary Screw Compressors

## UP-Series 5-15 HP

### Dual Filtration Pack

#### *Clean air to drive productivity*

- Two stages of filtration, proved to deliver best performance, lower pressure losses and longer operating life over time.
- Particulate removal to industry leading 1 micron.
- Oil removal down to .01 micron.
- Longer element life, lower pressure drop.
- Better air quality delivered to tools and equipment results in longer life.



### Energy Savings Refrigerated Air Dryer

#### *Dry air to drive productivity*

- Cycling dryer – automatically shuts off with the compressor, saving energy compared to traditional dryers which run continuously.
- Stainless steel braised heat exchanger for low losses, high thermal efficiency and long service life.
- Solenoid drain valve and high efficiency moisture separator to permanently discharge condensate.
- Eliminates corrosion of piping, a cause of premature wear of tools and seals.



# Integral air treatment

## Smart Integration

*Advanced packaging to drive reliability & uptime*

- Integrally cooled with common blower to ensure cooling is achieving 100% of time that compressor is running.
- Spacious design promoting serviceability.
- Package pre-filter for longer cooler life and lower pressure drops.
- Simplified piping – elimination of potential leaks.
- Single point condensate drain system instead of separate points – eliminates leaks.
- Patented segregated package cooling compartment provides advanced cooling flow management, and reduces noise level.

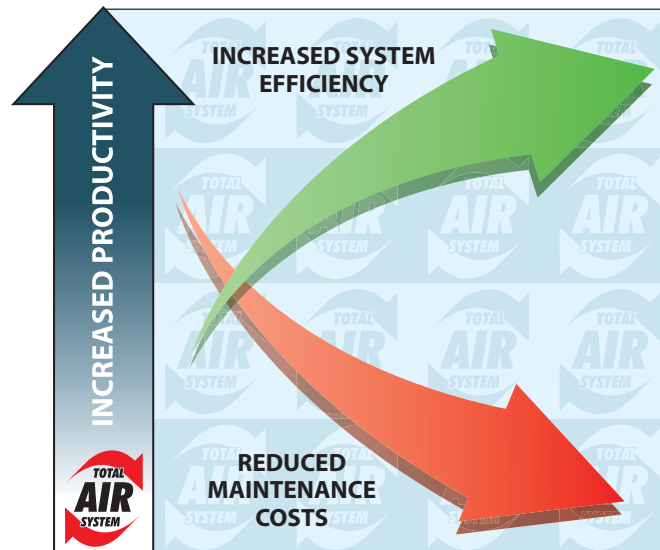
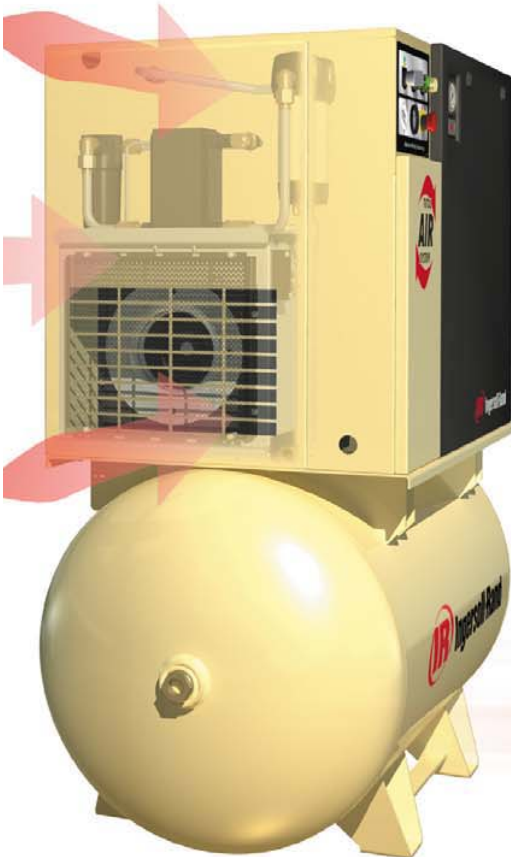

Choosing the  
**right air solution**  
has never been  
**easier...**

# Rotary Screw Compressors

## UP-Series 5-15 HP

# Asset protection

### Leading Warranty As Standard

- **5 Year Warranty Protection**  
All Ingersoll-Rand UP-Series compressors come standard with a one year package warranty and a 4-year extended parts warranty coverage.
- **AirCare Extended Coverage**  
In addition to the standard package warranty, all UP-Series compressors are available for extended AirCare coverage. Ask your authorized IR representative for more details.



### Ultra-Plus Coolant

All units come standard with Ingersoll-Rand's Ultra-Plus advanced synthetic coolant:



- 9,000 hour extended coolant life
- Simple condensate separation
- High level of biodegradability

### Ease Of Service

Ingersoll-Rand designed the UP-Series package with ease of service in mind. Spin-on oil filter and separator element along with 3,000/9,000 hour service intervals make life simple. Your IR Air Solutions provider will recommend the most cost effective maintenance program to keep your investment operating trouble free for years.

- **Service Supervisor On Board**

Keep your machine performing at its best. Eliminate the guesswork out of when to provide service, with the optional maintenance indicator.



### Parts Kits Make It Simple

Simple to order parts kits make it easy to ensure that you have the right parts on hand when you need them. Ingersoll-Rand's reputation for compressor parts availability and reliability is second to none.

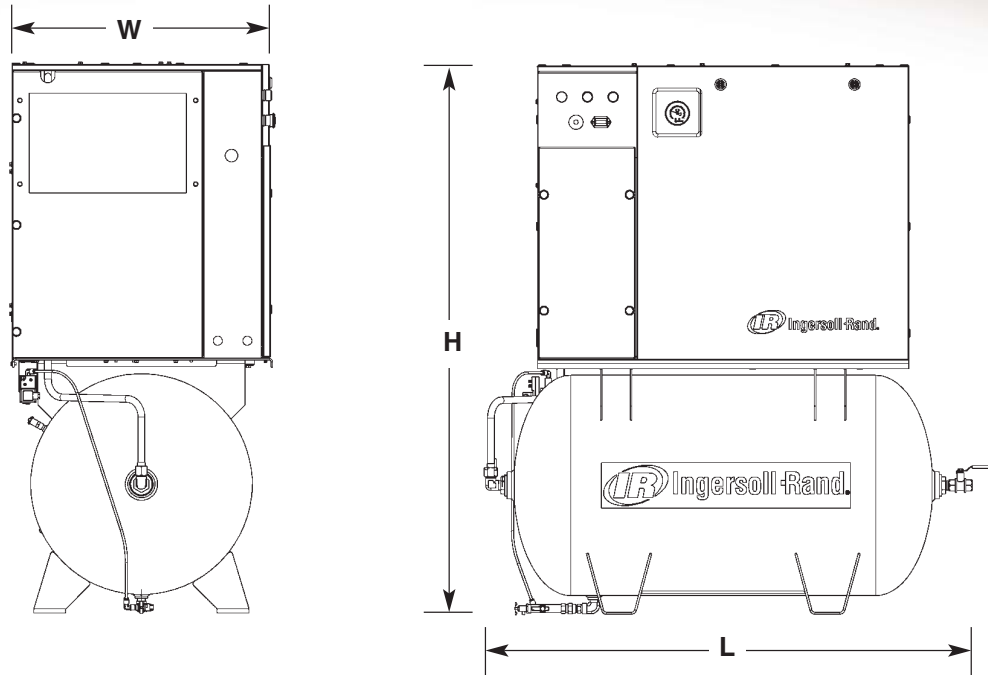

## Industry Leading Performance

60 Hertz Total Air System Specifications							60 Hertz Specifications - Without Air treatment System						
Model No.	HP	Discharge pressure Compressor Package		Capacity*			Model No.	HP	Discharge pressure PSIG		Capacity*		
		PSIG	PSIG	CFM	m <sup>3</sup> /min	dB(A)†			PSIG	PSIG	CFM	m <sup>3</sup> /min	dB(A)†
UP6-5TAS-125	5	125	115	18.5	0.52	65	UP6-5-125	5	125	18.5	0.52	65	
UP6-5TAS-150	5	150	140	16.0	0.45	65	UP6-5-150	5	150	16.0	0.45	65	
UP6-7TAS-125	7.5	125	115	28.0	0.79	65	UP6-7-125	7.5	125	28.0	0.79	65	
UP6-7TAS-150	7.5	150	140	25.0	0.25	65	UP6-7-150	7.5	150	25.0	0.25	65	
UP6-7TAS-210	7.5	210	200	17.5	0.50	65	UP6-7-210	7.5	210	17.5	0.50	65	
UP6-10TAS-125	10	125	115	38.0	1.08	68	UP6-10-125	10	125	38.0	1.08	68	
UP6-10TAS-150	10	150	140	34.0	0.96	68	UP6-10-150	10	150	34.0	0.96	68	
UP6-10TAS-210	10	210	200	24.0	0.68	68	UP6-10-210	10	210	24.0	0.68	68	
UP6-15cTAS-125	15	125	115	55.0	1.55	69	UP6-15c-125	15	125	55.0	1.55	69	
UP6-15cTAS-150	15	150	140	50.0	1.42	69	UP6-15c-150	15	150	50.0	1.42	69	
UP6-15cTAS-210	15	210	200	38.0	1.08	69	UP6-15c-210	15	210	38.0	1.08	69	

Dimensions & Weight							Machines without air treatment system			
50 & 60 Hertz baseplate and receiver mounted units							Weight		Weight	
	Length		Width		Height		pounds	kg	pounds	kg
	inch	mm	inch	mm	inch	mm				
<b>Base mount</b>	41	1042	28.9	734	36	914	725	330	650	295
80 Gallon Receiver Tank	53.6	1361	28.9	734	60.7	1541	1000	454	925	419
120 Gallon Receiver Tank	74.7	1897	28.9	734	60.7	1541	1035	470	960	435
272 Liter Receiver Tank	51.6	1311	28.9	734	60.7	1541	1003	455	928	420
500 Liter Receiver Tank	81	2059	28.9	734	60.7	1541	1080	490	1005	455

50 Hertz Total Air System Specifications							50 Hertz Specifications - Without Air treatment System						
Model No.	kW	Discharge pressure Compressor Package		Capacity*			Model No.	kW	Discharge pressure bar(g)		Capacity*		
		bar(g)	bar(g)	m <sup>3</sup> /min	CFM	dB(A)†			bar(g)	bar(g)	m <sup>3</sup> /min	CFM	dB(A)†
UP5-4TAS-8	4	8	7.3	0.55	19.5	65	UP5-4-8	4	8	0.55	19.5	65	
UP5-4TAS-10	4	10	9.3	0.45	16	65	UP5-4-10	4	10	0.45	16	65	
UP5-5TAS-8	5.5	8	7.3	0.82	29	65	UP5-5-8	5.5	8	0.82	29	65	
UP5-5TAS-10	5.5	10	9.3	0.74	26	65	UP5-5-10	5.5	10	0.74	26	65	
UP5-5TAS-14	5.5	14.5	13.8	0.51	18	65	UP5-5-14	5.5	14.5	0.51	18	65	
UP5-7TAS-8	7.5	8	7.3	1.08	38	68	UP5-7-8	7.5	8	1.08	38	68	
UP5-7TAS-10	7.5	10	9.3	0.96	34	68	UP5-7-10	7.5	10	0.96	34	68	
UP5-7TAS-14	7.5	14.5	13.8	0.68	24	68	UP5-7-14	7.5	14.5	0.68	24	68	
UP5-11cTAS-8	11	8	7.3	1.60	56.5	69	UP5-11c-8	11	8	1.60	56.5	69	
UP5-11cTAS-10	11	10	9.3	1.42	50	69	UP5-11c-10	11	10	1.42	50	69	
UP5-11cTAS-14	11	14.5	13.8	1.08	38	69	UP5-11c-14	11	14.5	1.08	38	69	

\* Performance in accordance with ISO 1217 1996 annex C

† Measured in accordance with CAGI-pneurop test code PN8NTC2.3



[www.air.irco.com](http://www.air.irco.com)



Ingersoll-Rand compressors are not designed, intended or approved for breathing air applications. Ingersoll-Rand does not approve specialised equipment for breathing air applications and assumes no responsibility or liability for compressors used for breathing air service.

Nothing contained on these pages is intended to extend any warranty or representation expressed or implied, regarding the product described herein. Any such warranties or other terms and conditions of sale of products shall be in accordance with Ingersoll-Rand's standard terms and conditions of sale for such products, which are available upon request.

Product improvement is a continuing goal at Ingersoll-Rand. Designs and specifications are subject to change without notice or obligation.



**Ingersoll-Rand  
Industrial Air Solutions**  
P.O. Box 1840  
800-D Beatty Street  
Davidson, NC 28036

**Ingersoll-Rand  
Industrial Air Solutions**  
Swan Lane  
Hindley Green  
Wigan, WN6 4EZ, UK

**Ingersoll-Rand  
Asia Pacific**  
c/o Ingersoll-Rand South East Asia (Pte) Ltd  
42, Benoi Road  
Singapore 629903